

Art.-Nr. 74.143

Wasserabweiser, Acryl transparent, für 8 mm Glas.

Gewicht: 0,106 kg/m

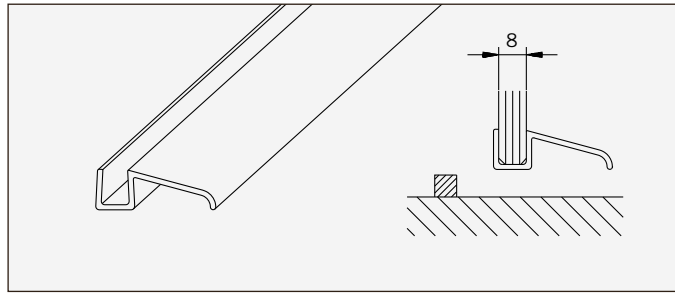

Art.-No. 74.143

Water disperser, transparent acrylic, for 8 mm glass.

Weight: 0,106 kg/m

Art.-Nr. 74.013

Wasserabweiser, Acryl transparent, mit weicher Lippe, für 8 mm Glas.
L: 2000 mm

Gewicht: 0,119 kg/m

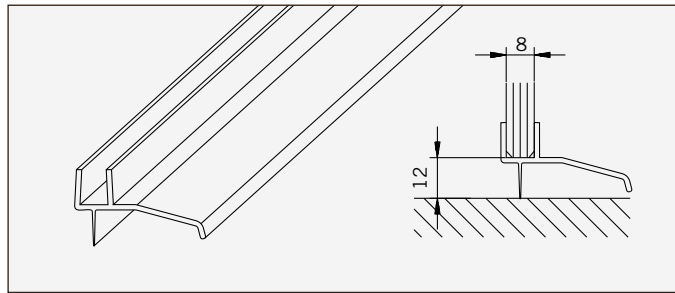

Art.-No. 74.013

Water disperser, transparent acrylic, with soft lip, for 8 mm glass.
L:2000 mm

Weight: 0,119 kg/m

Art.-Nr. 74.016

Wasserabweiser, Acryl transparent, für 6 und 8 mm Glas.
L: 2000 mm

Gewicht: 0,127 kg/m

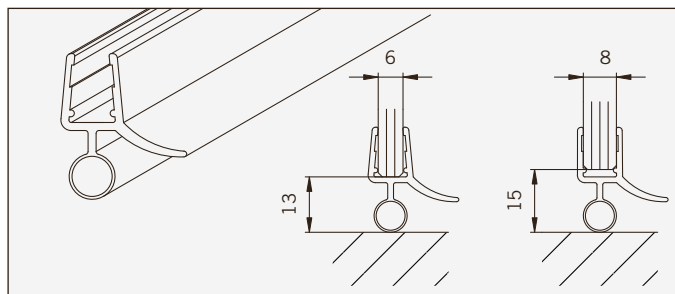

Art.-No. 74.016

Water disperser, transparent acrylic, for 6 and 8 mm glass, 2000 mm long

Weight: 0,127 kg/m

Art.-Nr. 74.017

Wasserabweiser, Acryl transparent, mit feinem Vollrundprofil und kurzem Glaseinstand für 8 mm Glas.
L: 2000 mm

Gewicht: 0,120 kg/m

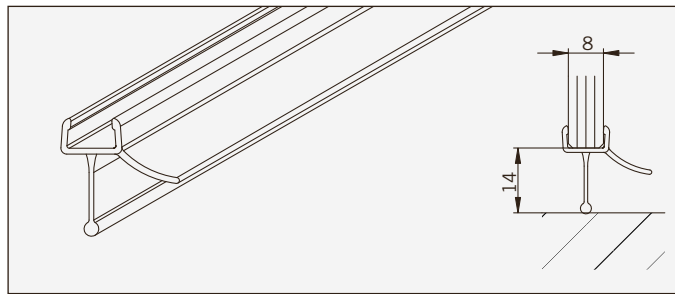

Art.-No. 74.017

Water disperser, transparent acrylic, with slim solid washer and short glass channel for 8 mm glass.
L: 2000 mm

Weight: 0,120 kg/m

Art. Nr. 74.018

Wasserabweiser, Acryl transparent, mit feinem Vollrundprofil und kurzem Glaseinstand für 6 mm Glas.
L: 2000 mm

Gewicht: 0,120 kg/m

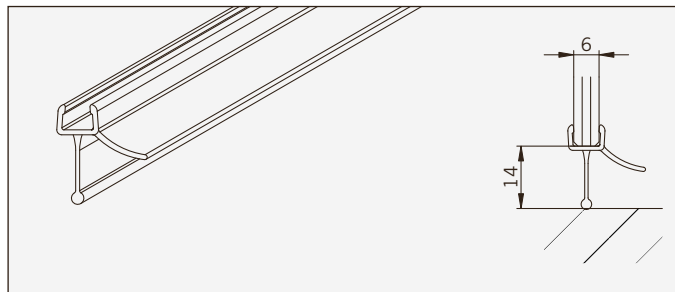

Art.-No. 74.018

Water disperser, transparent acrylic, with slim solid washer and short glass channel for 6 mm glass.
L: 2000 mm

Weight: 0,120 kg/m

Wasserabweiser mit feinem Vollrundprofil und kurzem Glaseinstand, für 6 mm Glas.

Art. Nr. 74.019
für Duschtypen 150/152

Art. Nr. 74.001
für Viertelkreisduschen

Gewicht: 0,120 kg/m



Water disperser with slim solid washer and short glass channel for 6 mm glass.

Art.-No. 74.019
for shower types 150/152

Art.-No. 74.001
for curved showers enclosures

Weight: 0,120 kg/m

Art.-Nr. 74.020

Unteres o. seitliches Dichtprofil,
Acryl transparent, mit weicher
Lippe, für 8 mm Glas.

L: 2000 mm

Art.-Nr. 74.021

L: 2500 mm

Gewicht: 0,074 kg/m

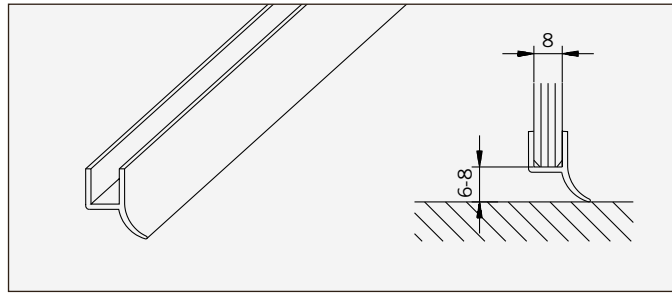

Art.-No. 74.020

Bottom or lateral sealing profile,
transparent acrylic, with soft lip,
for 8 mm glass.

L: 2000 mm

Art.-No. 74.021

L: 2500 mm

Weight: 0,074 kg/m

Art.-Nr. 74.022

Höhenausgleichprofil,
Acryl transparent,
für 8 mm Glas.

Gewicht: 0,134 kg/m

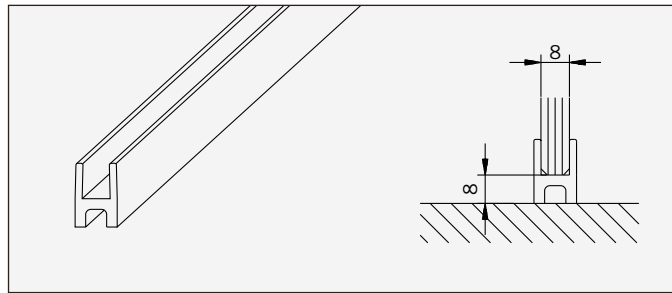

Art.-No. 74.022

Height compensation
profile, transparent acrylic,
for 8 mm glass.

Weight: 0,134 kg/m

Art.-Nr. 74.023

Anschlagdichtung 180°, acryl
transparent, mit weicher Lippe,
für 8 mm Glas.

L: 2000mm

Art.-Nr. 74.024

L: 2500 mm

Gewicht: 0,076 kg/m

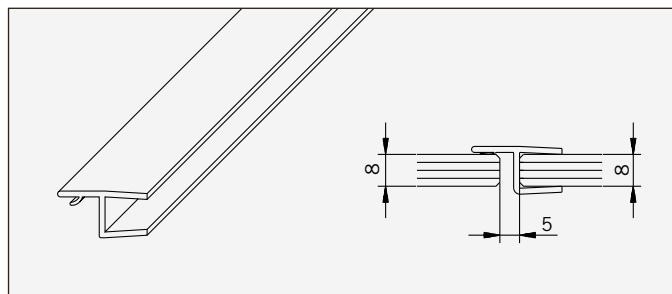

Art.-No. 74.023

Rebate seal 180°, transparent
acrylic, with soft lip,
for 8 mm glass.

L: 2000 mm

Art.-No. 74.024

L: 2500 mm

Weight: 0,076 kg/m

Art.-Nr. 74.025

Schlauchdichtung, Acryl
transparent mit kurzem
Glaseinstand, für 8 mm Glas.

L: 2000 mm

Art.-Nr. 74.026

L: 2500 mm

Gewicht: 0,080 kg/m

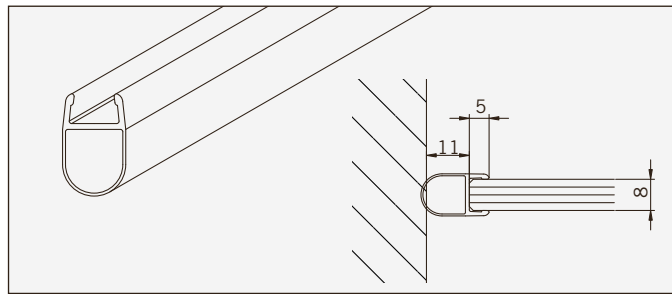

Art.-No. 74.025

Soft nose seal, transparent acrylic
with short glass channel,
for 8 mm glass.

L: 2000 mm

Art.-No. 74.026

L: 2500 mm

Weight: 0,080 kg/m

Art.-Nr. 74.027

Schlauchdichtung, Acryl
transparent mit kurzem
Glaseinstand, für 6 mm Glas.

L: 2000 mm

Art.-Nr. 74.028

L: 2500 mm

Gewicht: 0,080 kg/m

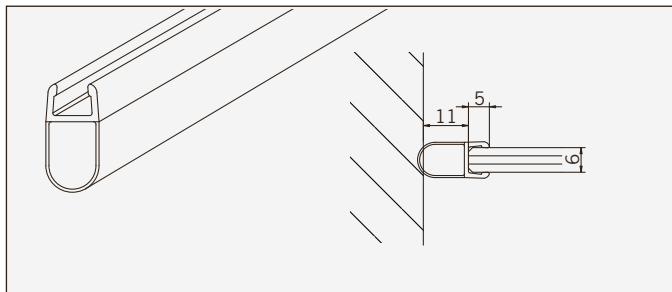

Art.-No. 74.027

Soft nose seal, transparent acrylic
with short glass channel,
for 6 mm glass.

L: 2000 mm

Art.-No. 74.028

L: 2500 mm

Weight: 0,080 kg/m

Art.-Nr. 74.029

Anschlagdichtung 90°, Acryl
transparent, mit weicher Lippe,
für 8 mm Glas.

L: 2000 mm

Art.-Nr. 74.030

L: 2500mm

Gewicht: 0,075 kg/m

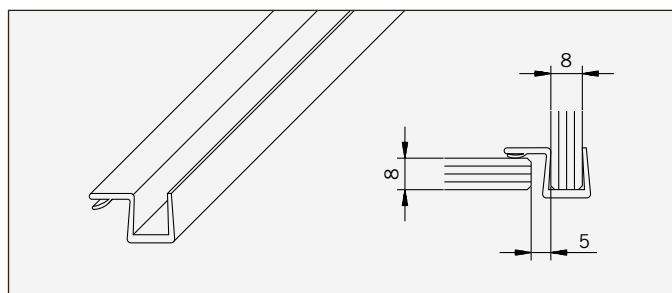

Art.-No. 74.029

Rebate seal 90°, transparent
acrylic, with soft lip,
for 8 mm glass.

L: 2000mm

Art.-No. 74.030

L: 2500mm

Weight: 0,075 kg/m

Art.-Nr. 74.031

Mitteldichtung 180°,
Acryl transparent,
für 6 mm Glas.

L: 2000 mm

Art.-Nr. 74.032

L: 2500 mm

Gewicht: 0,032 kg/m

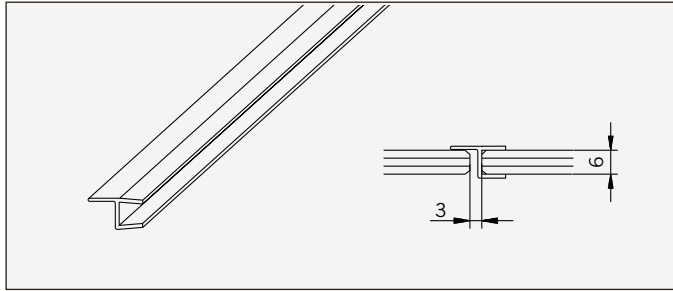

Art.-No. 74.031

Middle seal 180°,
transparent acrylic,
for 6 mm glass.

L: 2000 mm

Art.-No. 74.032

L: 2500 mm

Weight: 0,032 kg/m

Art.-Nr. 74.033

Mitteldichtung 135°, Acryl
transparent, für 8 mm Glas,
für Fünfeckkabinen oder als
Wanddichtung verwendbar.

L: 2000 mm

Art.-Nr. 74.034

L: 2500 mm

Gewicht: 0,066 kg/m

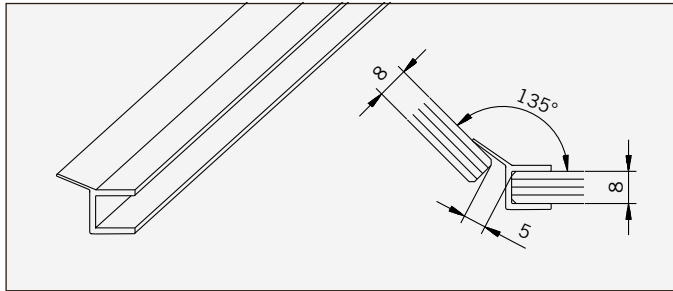

Art.-No. 74.033

Middle seal 135°, transparent
acrylic, for 8 mm glass, for
pentagonal showers or can be
used as wall seal.

L: 2000 mm

Art.-No. 74.034

L: 2500 mm

Weight: 0,066 kg/m

Art.-Nr. 74.035

Wanddichtung, Acryl transparent,
mit weicher Lippe,
für 6-8 mm Glas.

L: 2000 mm

Art.-Nr. 74.036

L: 2500 mm

Gewicht: 0,078 kg/m

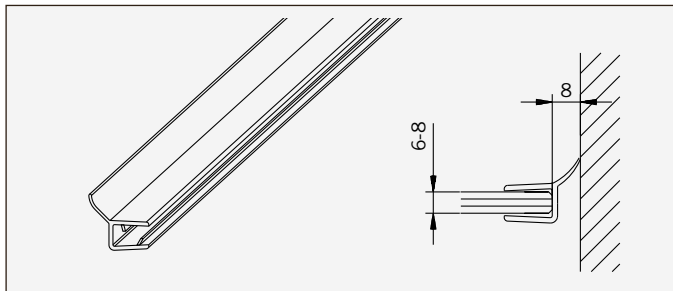

Art.-No. 74.035

Wall seal, transparent
acrylic, with soft lip,
for 6-8 mm glass.

L: 2000 mm

Art.-No. 74.036

L: 2500 mm

Weight: 0,078 kg/m

Art.-Nr. 74.037

U-Ausgleichprofil,
Acryl transparent,
für 6 mm Glas.

Gewicht: 0,031 kg/m

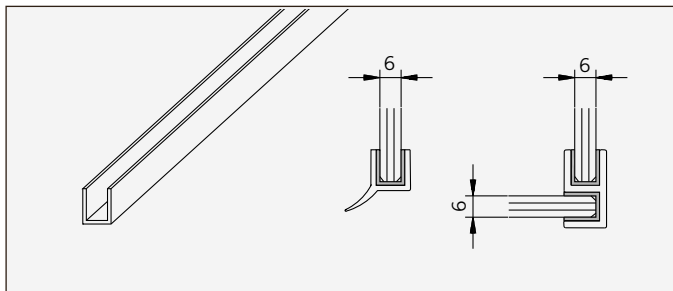

Art.-No. 74.037

U-compensation profile,
transparent acrylic,
for 6 mm glass.

Weight: 0,031 kg/m

Art.-Nr. 74.039

Anschlagdichtung, PVC weich,
für Aluminiumprofile 74.105 und
74.106.

Gewicht: 0,016 kg/m

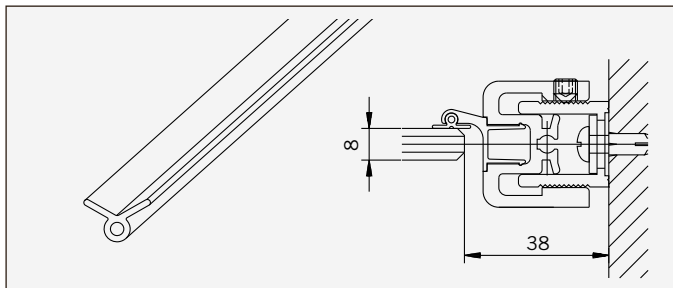

Art.-No. 74.039

Rebate seal, PVC soft, for
aluminium profiles 74.105
and 74.106.

Weight: 0,016 kg/m

Art.-Nr. 74.040

Gummihohldichtung, PVC weich,
für Aluminiumprofil 74.108.

Gewicht: 0,029 kg/m

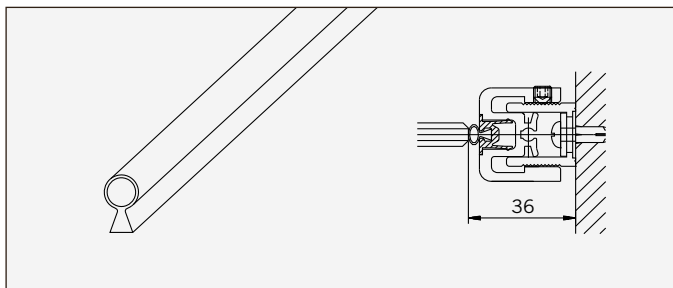

Art.-No. 74.040

Hollow rubber profile, PVC soft,
for aluminium profile 74.108.

Weight: 0,029 kg/m

Art.-Nr. 74.041

Eck-Verbindungsprofil 90°,
Acryl transparent,
für 8 mm Glas.

Gewicht: 0,130 kg/m

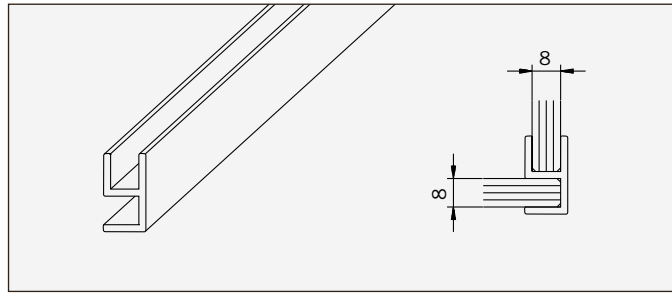

Art.-No. 74.041

Corner connection profil 90°,
transparent acrylic,
for 8 mm glass.

Weight: 0,130 kg/m

Art.-Nr. 74.042

Glasschutz 11 mm, PVC
weich. Schützt das Glas beim
Einsetzen in Metallprofile.

Gewicht: 0,036 kg/m

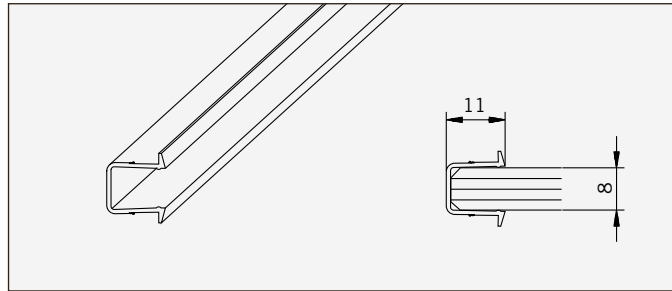

Art.-No. 74.042

Glass protection 11 mm, PVC
soft. Protects the glass during
insertion into the metal profiles.

Weight: 0,036 kg/m

Art.-Nr. 74.043

Glasschutz 17,5 mm, PVC weich.
Schützt das Glas beim Einsetzen
in Metallprofile.

Gewicht: 0,050 kg/m

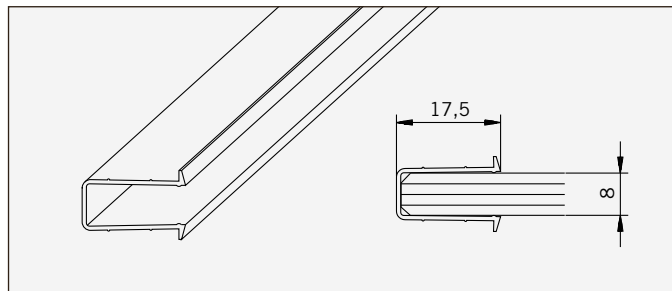

Art.-No. 74.043

Glass protection 17.5 mm, PVC
soft. Protects the glass during
insertion into the metal profiles.

Weight: 0,050 kg/m

Art.-Nr. 74.044

Magnetdichtung 135°, als
180°-Verbindung, Acryl trans-
parent, Lieferung paarweise.
Für 6-8 mm Glas.
L: 2000 mm

Art.-Nr. 74.045

L: 2500 mm

Gewicht: 0,102 kg/m

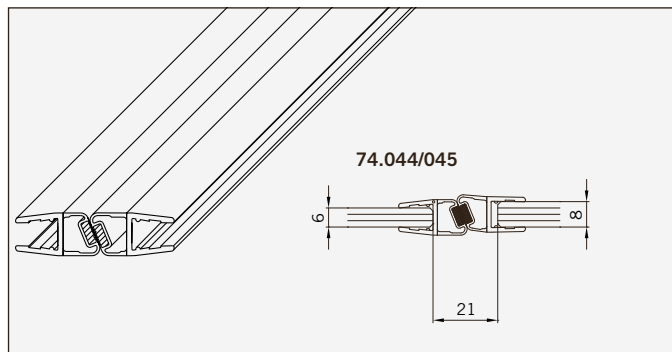

Art.-No. 74.044

Magnetic seal 135°, for 180°
connection, transpa-rent acrylic,
supplied in pairs. For 6-8 mm
glass.
L: 2000 mm

Art.-No. 74.045

L: 2500 mm

Weight: 0,102 kg/m

Art.-Nr. 74.048

Magnetdichtung 135°, als
135°-Verbindung, Acryl trans-
parent, Lieferung paarweise.
Für 6-8 mm Glas,
L: 2000 mm

Art.-Nr. 74.049

Für 6-8 mm Glas,
L: 2500 mm

Gewicht: 0,102 kg/m

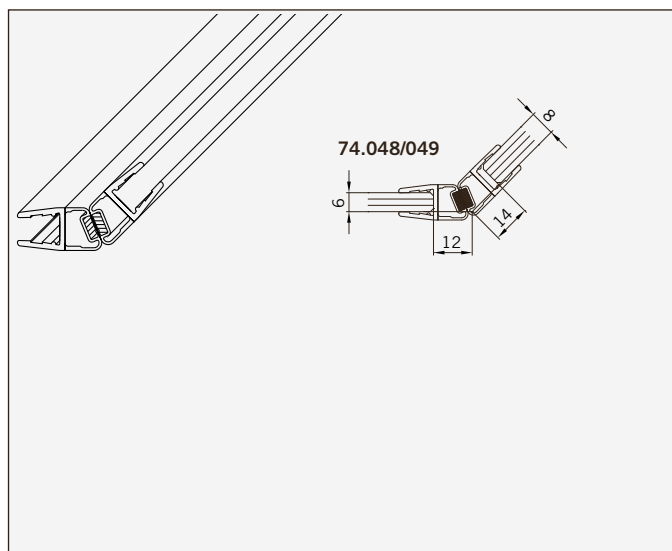

Art.-No. 74.048

Magnetic seal 135°, for 135°
connection, transpa-rent acrylic,
supplied in pairs. For 6-8 mm
glass,
L: 2000 mm

Art.-No. 74.049

For 6-8 mm glass,
L: 2500 mm

Weight: 0,102 kg/m

Art.-Nr. 74.052

Magnetdichtung 90°,
Acryl transparent,
Lieferung paarweise.
Für 6-8 mm Glas,
L: 2000 mm

Art.-Nr. 74.053

Für 6-8 mm Glas,
L: 2500 mm

Gewicht: 0,102 kg/m

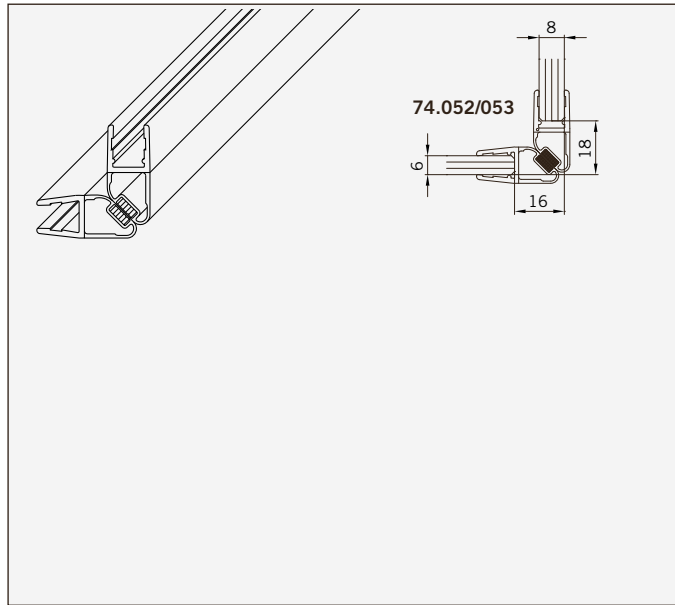

Art.-No. 74.052

Magnetic seal 90°, transparent
acrylic,
supplied in pairs.
For 6-8 mm glass,
L: 2000 mm

Art.-No. 74.053

For 6-8 mm glass,
L: 2500 mm

Weight: 0,102 kg/m

Art.-Nr. 74.060

Universalmagnetdichtung,
für 90° bis 180°- Verbindungen,
Lieferung paarweise,
für 6-8 mm Glas.
L: 2000 mm

Art.-Nr. 74.061

L: 2500 mm

Gewicht: 0,320 kg/m

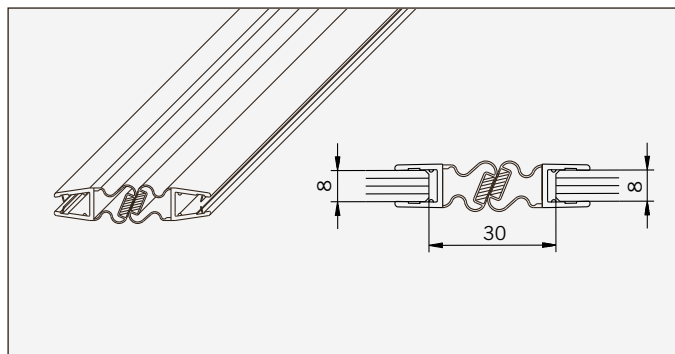

Art.-No. 74.060

Universal magnetic seal,
for 90° to 180°connection,
supplied in pairs,
for 6-8 mm glass,
L: 2000 mm

Art.-No. 74.061

L: 2500 mm

Weight: 0,320 kg/m

Art.-Nr. 74.062

H-Profil, groß, Acryl transparent,
für 8 mm Glas,
L: 2000 mm

Art.-Nr. 74.063

L: 2500 mm

Gewicht: 0,071 kg/m

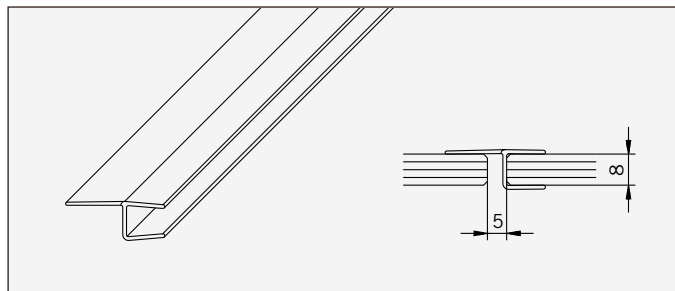

Art.-No. 74.062

H-profile, large, transparent acrylic,
for 8 mm glass,
L: 2000 mm

Art.-No. 74.063

L: 2500 mm

Weight: 0,071 kg/m

Art.-Nr. 74.056

Magnetdichtung 180°,
Acryl transparent,
Lieferung paarweise.
Für 6-8 mm Glas,
L: 2000 mm

Art.-Nr. 74.057

Für 6-8 mm Glas,
L: 2500 mm

Gewicht: 0,086 kg/m

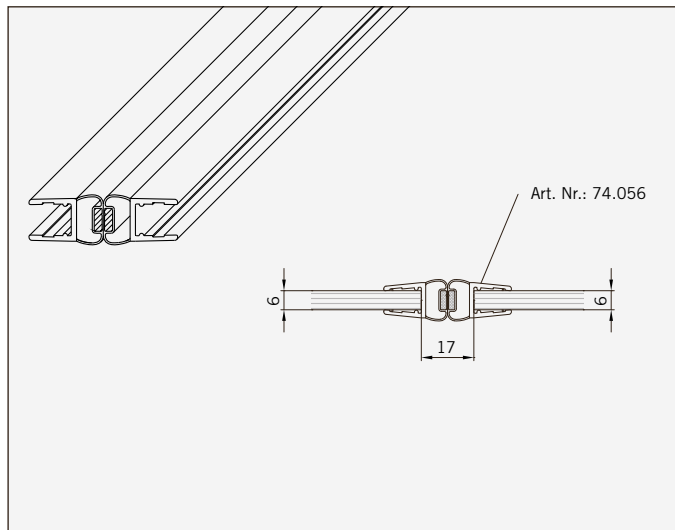

Art.-No. 74.056

Magnetic seal 180°, transparent
acrylic,
supplied in pairs.
For 6-8 mm glass,
L: 2000 mm

Art.-No. 74.057

For 6-8 mm glass,
L: 2500 mm

Weight: 0,086 kg/m

Art.-Nr. 74.064
Mitteldichtung, rund,
Acryl transparent,
für 8mm Glas,
L: 2000 mm
Art.-Nr. 74.065
L: 2500 mm

Gewicht: 0,067 kg/m

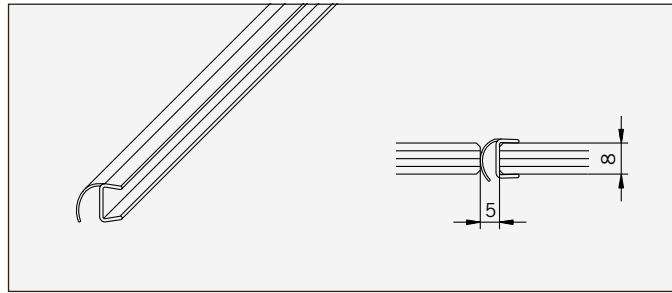

Art.-No. 74.064
Middle seal, round,
transparent acrylic,
for 8mm glass,
L: 2000 mm
Art.-No. 74.065
L: 2500 mm

Weight: 0,067 kg/m

Art.-Nr. 74.069
Dichtprofil, Acryl transparent.
Zur zusätzlichen Abdichtung bei
ungünstigen Wannensituationen.

Gewicht: 0,130 kg/m

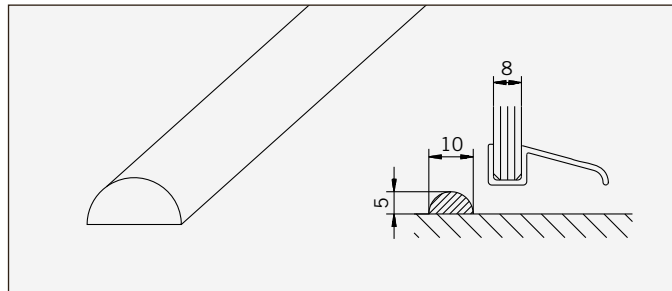

Art.-No. 74.069
Sealing profile, transparent
acrylic. For additional sealing
in case bathtub is placed
unfavorably.

Weight: 0,130 kg/m

Art.-Nr. 74.070
Dichtprofil, Acryl transparent, zur
zusätzlichen Abdichtung bei
ungünstiger Wannensituation.
L: 2000 mm

Gewicht: 0,200 kg/m



Art.-No. 74.070
Sealing profile,
transparent acrylic,
for additional sealing in case
bathtub is placed unfavorably.
L: 2000 mm

Weight: 0,200 kg/m

Art.-Nr. 74.071
Mitteldichtung 135°, Acryl
transparent, für 6 mm Glas, für
Fünfeckkabinen.
L: 2000 mm

Art.-Nr. 74.072
L: 2500 mm
Gewicht: 0,057 kg/m

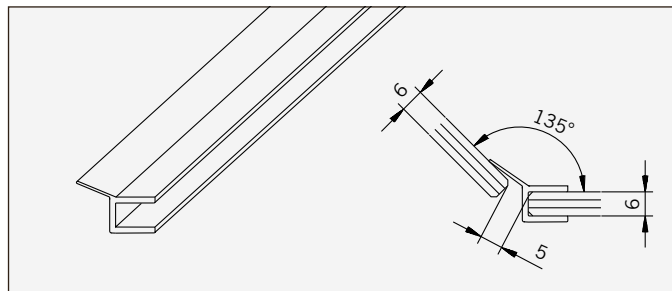

Art.-No. 74.071
Middle seal 135°, transpa-rent
acrylic, for 6 mm glass, for
pentagonal showers.
L: 2000 mm

Art.-No. 74.072
L: 2500 mm
Weight: 0,057 kg/m

Art.-Nr. 74.075
H-Profil, klein, Acryl transparent,
für 8 mm Glas.
L: 2000 mm

Art.-Nr. 74.076
L: 2500 mm

Gewicht: 0,061 kg/m

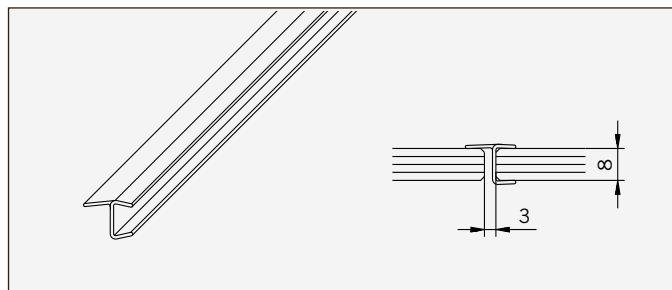

Art.-No. 74.075
H-profile, small, transparent
acrylic, for 8 mm glass.
L: 2000 mm

Art.-No. 74.076
L: 2500 mm

Weight: 0,061 kg/m

Art.-Nr. 74.077

Lippendichtung,
für 8 mm Glas.

Gewicht: 0,086 kg/m



Art.-No. 74.077

Lip seal,
for 8 mm glass.

Weight: 0,086 kg/m

Art.-Nr. 74.078

Lippendichtung,
für 8 mm Glas.

Gewicht: 0,093 kg/m

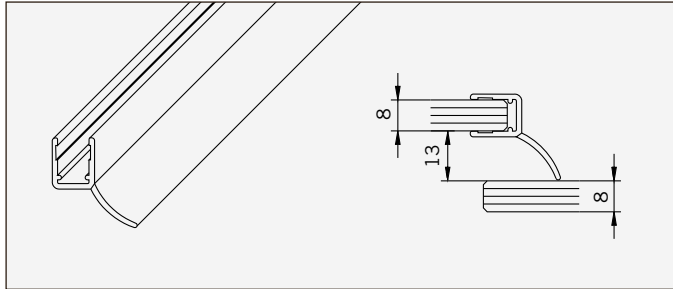

Art.-No. 74.078

Lip seal,
for 8 mm glass.

Weight: 0,093 kg/m

Art.-Nr. 74.079

Schlauchdichtung,
für 6-8 mm Glas.
L: 2000 mm

Art.-Nr. 74.080

L: 2500 mm

Gewicht: 0,081 kg/m

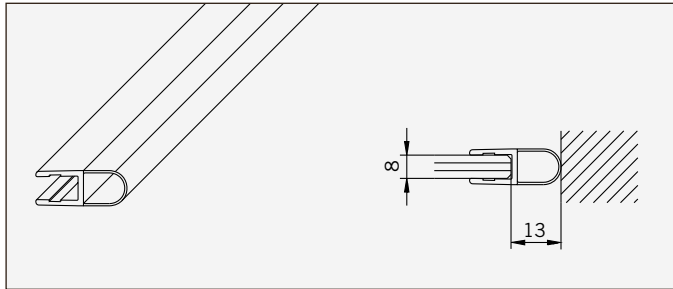

Art.-No. 74.079

Soft nose seal,
for 6-8 mm glass.
L: 2000 mm

Art.-No. 74.080

L: 2500 mm

Weight: 0,081 kg/m

Art.-Nr. 74.083

Schlauchdichtung,
für 6-8 mm Glas.

Art. Nr. 74.084

L: 2500 mm

Gewicht: 0,076 kg/m



Art.-No. 74.083

Soft nose seal,
for 6-8 mm glass.

Art.-No. 74.084

L: 2500 mm

Weight: 0,076 kg/m

Art.-Nr. 74.087

Anschlagdichtung 90°,
für 8 mm Glas.

Gewicht: 0,099 kg/m

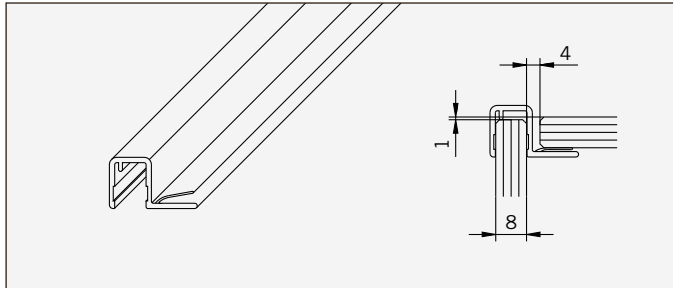

Art.-No. 74.087

Rebate seal 90°,
for 8 mm glass.

Weight: 0,099 kg/m

Art.-Nr. 74.089

Lippendichtung,
für 8 mm Glas.

Gewicht: 0,079 kg/m

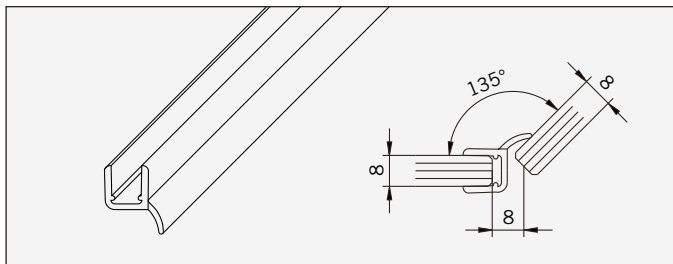

Art.-No. 74.089

Lip seal,
for 8 mm glass.

Weight: 0,079 kg/m

Art.-Nr. 74.092

Dichtung mit langer Lippe,
für 6 mm Glas.

Gewicht: 0,095 kg/m

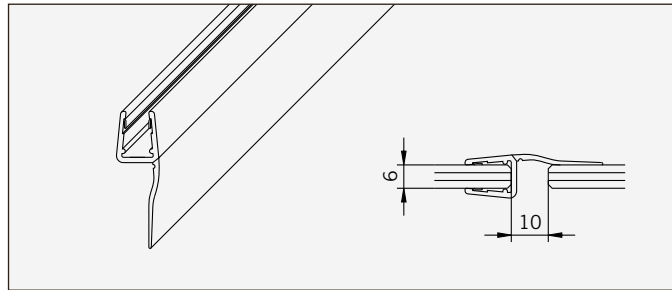

Art.-No. 74.092

Seal with long lip,
for 6 mm glass.

Weight: 0,095 kg/m

Art.-Nr. 74.093

Wasserabweiser mit weicher
Lippe, für 6 mm Glas.

Gewicht: 0,096 kg/m



Art.-No. 74.093

Water disperser with soft lip,
for 6 mm glass.

Weight: 0,096 kg/m

Art.-Nr. 74.094

Lippendichtung,
für 8 mm Glas.

Gewicht: 0,064 kg/m

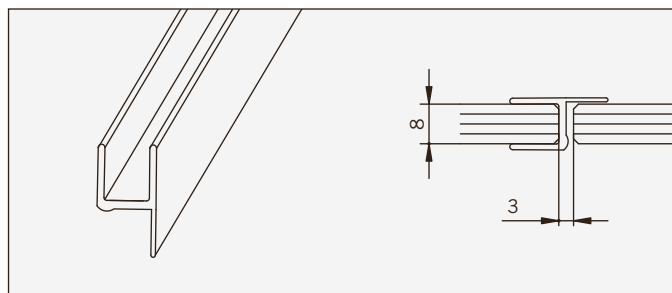

Art.-No. 74.094

Lip seal,
for 8 mm glass.

Weight: 0,064 kg/m

Art.-Nr. 74.095

Spaltdichtung,
für 8 mm Glas.

Gewicht: 0,087 kg/m

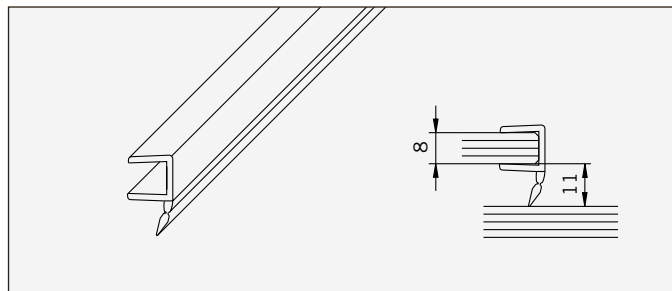

Art.-No. 74.095

Gap seal,
for 8 mm glass.

Weight: 0,087 kg/m

Art.-Nr. 74.002

Mitteldichtung für Schiebetüren
der Baureihen SO 730x
(Typ 360), für 6-8 mm Glas

Gewicht: 0,099 kg/m

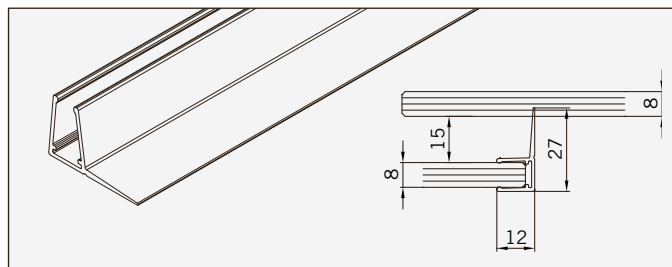

Art.-No. 74.002

Middle seal for
SO 730x sliding door system
(type 360), for 6-8 mm glass

Weight: 0,099 kg/m

Art.-Nr. 74.051

Magnetdichtung 90°
für Pendeltüren,
Acryl transparent,
Lieferung paarweise.
Für 6-8 mm Glas

L: 2500 mm

Gewicht: 0,408 kg

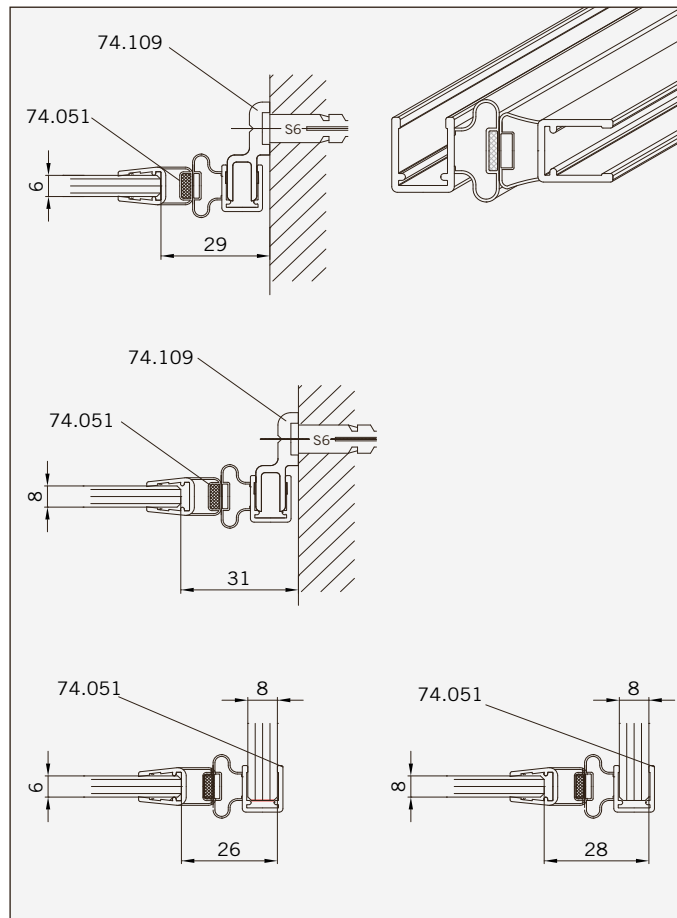

Art.-No. 74.051

Magnetic seal for 90°
double action doors,
transparent acrylic,
supplied in pairs.
For 6-8 mm glass.

L: 2500 mm

Weight: 0,408 kg

Art.-Nr. 74.055

Magnetdichtung 135°
für Pendeltüren,
Acryl transparent,
Lieferung paarweise.
Für 6-8 mm Glas

L: 2500 mm

Gewicht: 0,408 kg

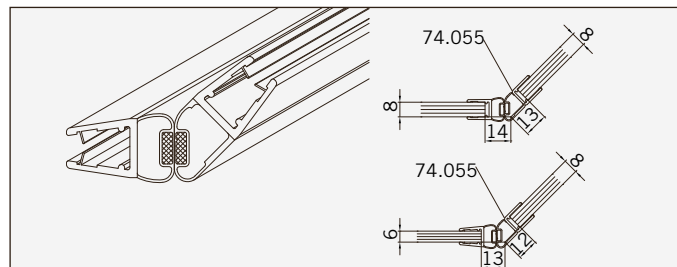

Art.-No. 74.055

Magnetic seal for 135°
double action doors,
transparent acrylic,
supplied in pairs.
For 6-8 mm glass.

L: 2500 mm

Weight: 0,408 kg

Art.-Nr. 74.156

Schlauchdichtung
für Glas/Glas 180°
Pendeltürbeschläge,
Acryl transparent,
Für 8 mm Glas

L: 2500 mm

Gewicht: 0,100 kg

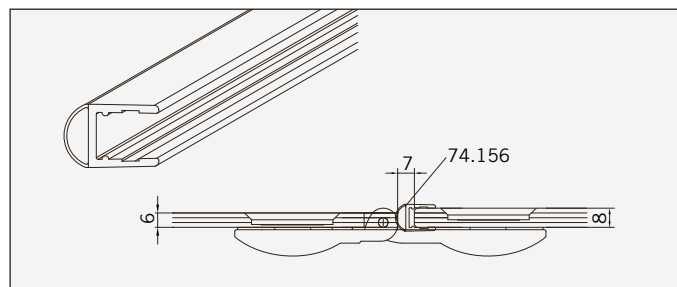

Art.-No. 74.156

Soft nose seal for
glass/glass 180°
double action hinges,
transparent acrylic,
For 6-8 mm glass.

L: 2500 mm

Weight: 0,408 kg

Art.-Nr. 74.157

Mitteldichtung rund für
135° Pendeltürbeschläge,
Acryl transparent,

Für 8 mm Glas

L: 2500 mm

Gewicht: 0,408 kg

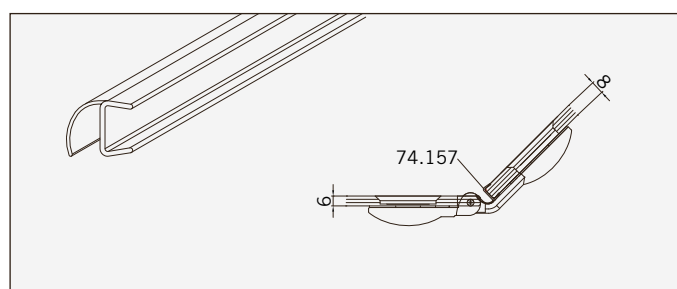

Art.-No. 74.157

Middle seal round for
glass/glass 135°
double action hinges,
transparent acrylic.
For 8 mm glass.

L: 2500 mm

Weight: 0,408 kg