

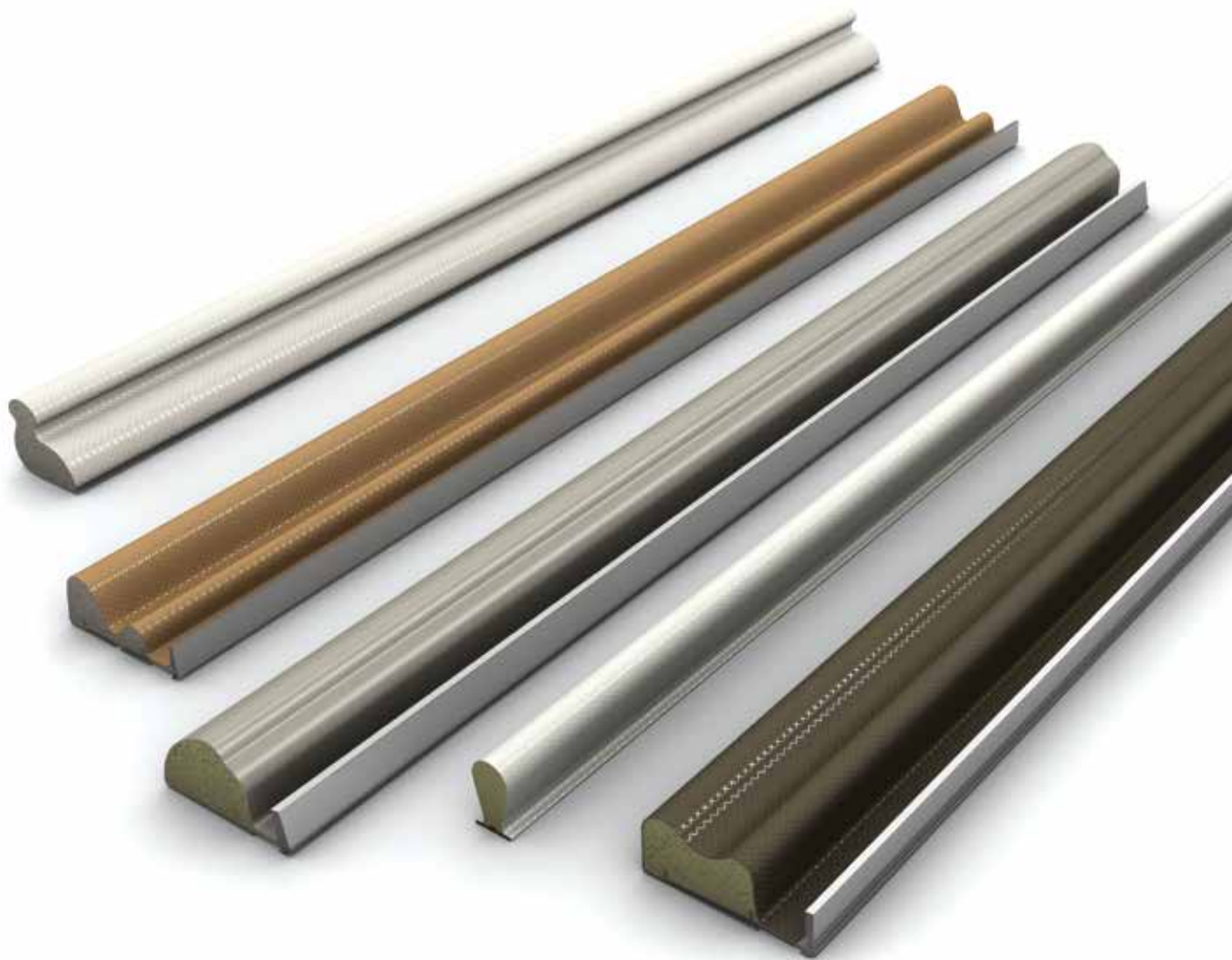

Q-Lon Polyurethane Foam Seals: for timber, PVCu and aluminium applications

LONG LASTING SEALING PERFORMANCE



The Schlegel
Promise!

Q-Lon Polyurethane Foam Seals: for timber, PVCu and aluminium applications

ABOUT SCHLEGEL	3
----------------	---

Q-LON POLYURETHANE FOAM SEALS	4
----------------------------------	---

Q-LON POLYURETHANE FOAM SEALS: OVERVIEW SEAL RANGE	6
---	---

UNIVERSAL SURFACE FITTED APPLICATIONS	10
--	----

TIMBER WINDOW AND ENTRY DOOR APPLICATIONS	12
--	----

PVCu WINDOW AND DOOR AND WINDOW COVERING PRODUCT APPLICATIONS	20
---	----

ALUMINIUM WINDOW AND DOOR AND WINDOW COVERING PRODUCT APPLICATIONS	28
--	----

INTERIOR DESIGN: INTERNAL DOOR AND FURNITURE APPLICATIONS	32
--	----

ACCESSORIES AND TOOLS	40
-----------------------	----

COLOUR RANGE	42
--------------	----

WHICH SEAL HAS THE LOWEST CONDUCTIVITY?	43
--	----



Schlegel: providing experience in the best sealing technology

With almost 50 years of global experience in the design and manufacture of outstanding window and door products, it is little wonder that Schlegel has become the industry's first choice for foam, brush and extruded seals.

The unique Q-Lon seal has been developed in consultation with our customers to offer the widest range of polyurethane (PU) foam seals possible for timber, PVCu and aluminium windows and doors, window covering products and interior design. The unique design has made Q-Lon the seal of choice for many applications. Authentic Q-Lon seals are impervious to paint and stain, while still providing some of the best energy saving performance characteristics currently available.

Our products are manufactured to meet the requirements of many current and proposed British, German, Spanish and related European and international standards and are manufactured using a Quality Management System registered and certified to norm ISO 9001:2008. Backed by our 10 year guarantee, original Q-Lon seals are a safe choice. Compared with common sealing systems, the Q-Lon range provides a cost effective way of offering continuous high standards of sealing, year after year.



10
Year
Guarantee

Tested and certified by:



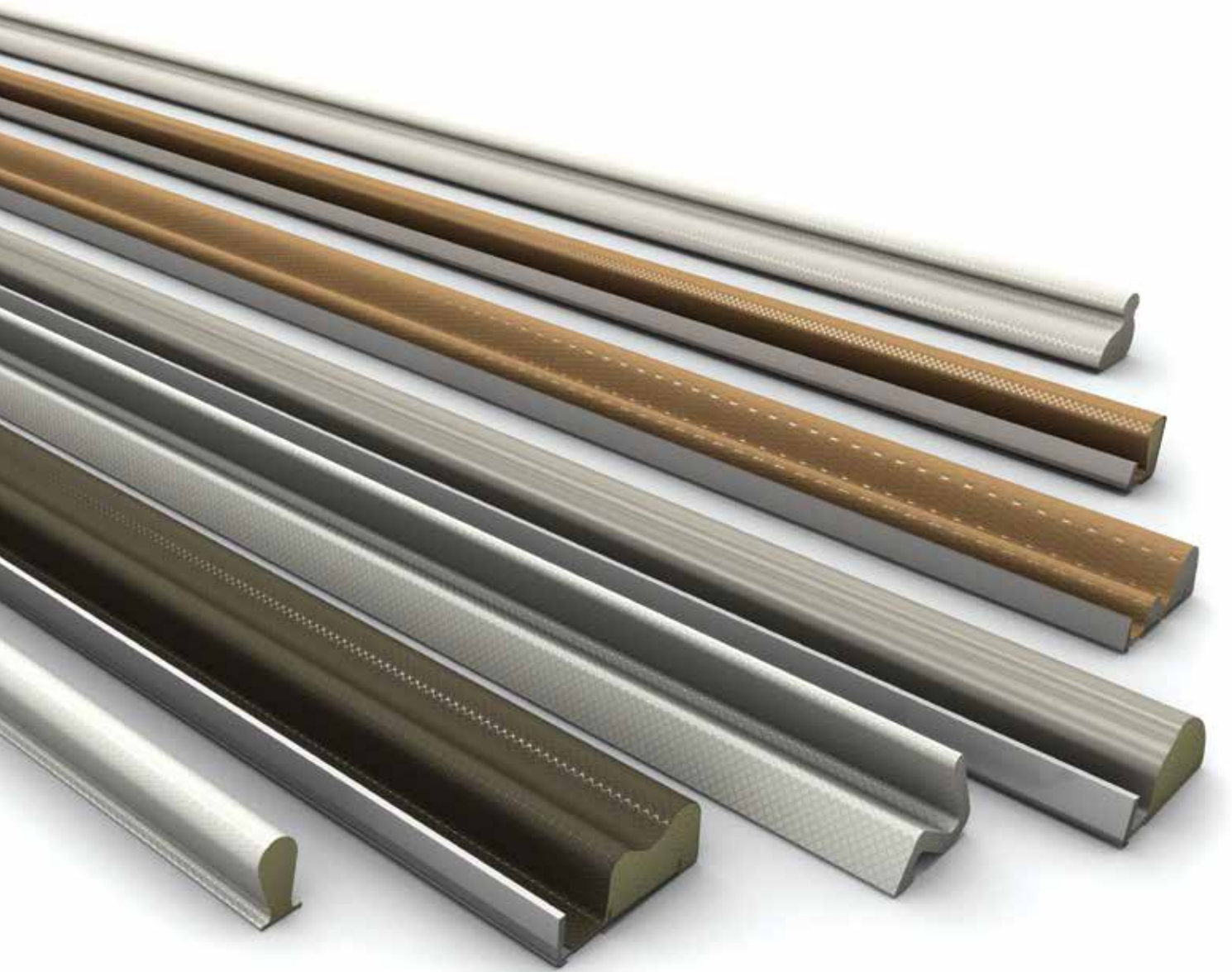

- Polyurethane (PU) foam core – high durability, superior recovery performance
- Polyethylene (PE) film – weather and UV-resistant
- Glass fibre thread or polypropylene (PP) insert – prevents elongation and shrinkage
- Smooth or embossed exterior, resistant to contamination
- Compatible with cleaning agents

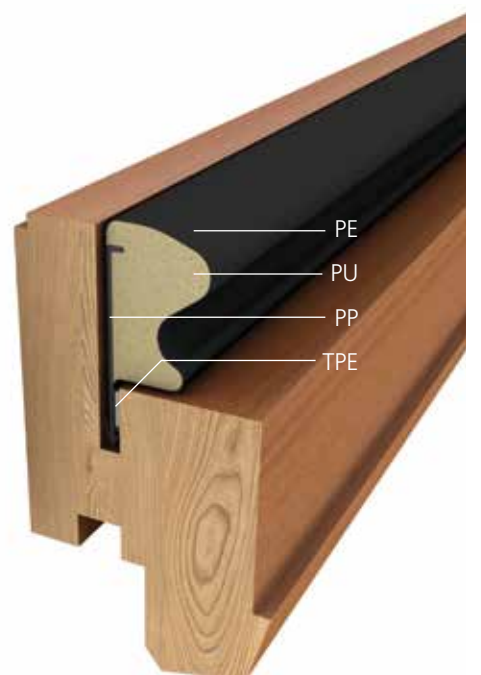

Q-Lon Polyurethane Foam Seals: proved and tested for almost 50 years

Made with a unique combination of materials and with technical performance unparalleled by any other material used in seals, Schlegel Q-Lon offers the highest standard of sealing function – even under extreme conditions.

Continuous research and development, as well as strict material inspection and quality inspections, have made Q-Lon one of the best established sealing systems in the industry today.

Q-Lon foam seals – the ultimate benefits in material and function:

- **Excellent memory** – returns to original shape after long compression
- **Stability** – low / no stretch gained by rigid insert or glass fibre internal cord
- **Easily compressed** – low compression forces, unaffected by temperature variance
- **Acoustics** – outstanding acoustic performance
- **Thermal conductivity** – unrivalled thermal performance
- **Paint and stain proof** – properties unaffected by standard paints and stains
- **Stabilised** – unaffected by rot, fungi, UV-light or ozone
- **Colours** – white, black, brown, grey and many other options
- **Temperatures** – wide operating range under extremely cold and warm weather conditions

Independent Testing

Q-Lon has been extensively tested by independently certified test facilities that clearly demonstrate its superior performance over other commonly used seal materials and constructions. In particular, it has been shown that Q-Lon seals retain their properties and performance significantly better over time when, after 10,000 cycles of window and / or door opening and closing, other materials lose their ability to meet the normal operational requirements.

Areas affected include weathering performance, thermal insulation, sound attenuation and air tightness.

A good guide to the performance of weatherseals and gaskets can be found in EN 12365:2003. For a greater insight into this and other performance norms please refer to the Schlegel 'Guide to Weatherseal Selection & Specification in Europe'.



Q-Lon Polyurethane Foam Seals: overview seal range

Universal surface fitting

Surface-fit	Dimensions (mm)			
	Seal		Application	
	Width	Height	Rebate	Seal Gap
Taped				
QL 1026	12,0	4,0	12,0	1,0 - 3,0
QL 1032	12,0	7,0	12,0	2,0 - 6,0
QL 3015	8,0	5,0	8,0	2,5 - 4,0
QL 3116	10,8	8,7	11,0	3,0 - 5,5
QL 3117	11,2	6,5	11,0	3,0 - 5,5
QL 3121	15,0	12,0	15,0	5,0 - 10,0
QL 3122	7,0	2,2	7,0	0,5 - 2,0
QL 3124	6,4	3,7	6,0	2,5 - 3,5
QL 3126	10,0	3,0	10,0	1,0 - 2,5
Untaped				
QL 3042	11,2	6,5	11,0	3,0 - 5,5
QL 3059	10,8	8,7	11,0	3,0 - 5,5
QL 3061	15,0	12,0	15,0	5,0 - 10,0

Timber entry doors

Kerf-Slot	Dimensions (mm)			
	Groove		Rebate	Seal Gap
	Throat Width	Min. Depth		
QL 3073	4,0 - 5,0	7,5	13,0	5,0 - 8,0
QL 3078	3,0 - 3,3	6,0	10,5	4,0 - 7,5
QL 3091	4,0 - 5,0	7,5	15,0	4,0 - 8,0
QL 3093	2,7 - 3,0	7,0	13,0	4,0 - 8,0
QL 3094	2,7 - 3,2	6,5	10,0	3,0 - 6,0
QL 3095	3,5 - 4,0	6,5	10,0	3,0 - 6,0
QL 3096	4,0 - 5,0	7,5	12,0	3,0 - 6,0
QL 3097	4,0 - 5,0	7,5	18,0	3,5 - 6,0
QL 3098	3,0 - 4,0	7,5	14,0	3,0 - 6,0
QL 3099	3,0 - 3,3	6,0	10,5	4,0 - 7,5
QL 3102	3,7 - 4,2	7,0	11,0	5,0 - 7,5
QL 3104	4,0 - 5,0	7,5	12,0	5,0 - 9,0
QL 3109	4,0 - 5,0	7,0	18,0	5,0 - 9,0
QL 3118	3,0 - 3,3	7,0	9,0	3,0 - 7,5
QL 5694	2,7 - 3,0	6,0	10,0	6,0 - 11,0
QL 7000	2,7 - 3,0	6,0	10,0	4,0 - 10,8
QL 7066	2,7 - 3,0	6,0	10,0	4,8 - 7,7
QL 9111	3,0 - 3,3	6,0	12,0	4,8 - 7,9



Timber windows

Kerf-Slot	Groove		Rebate	Seal Gap
	Throat Width	Min. Depth		
Centre Seal				
QL 3053	4,0 - 5,0	7,5	12,0	4,5 - 6,0
QL 3063	4,0 - 5,0	7,5	12,0	5,5 - 7,5
QL 3067	4,0 - 5,0	7,5	12,0	4,0 - 6,0
QL 3068	3,4 - 4,2	6,5	11,0	4,5 - 6,5
QL 3072	2,7 - 3,2	6,5	10,0	2,7 - 4,3
QL 3076	3,0 - 3,5	6,0	10,0	3,0 - 6,0
QL 3079	3,2 - 4,0	6,5	10,0	2,7 - 4,3
QL 3101	2,7 - 3,2	7,0	13,0	3,5 - 6,0
QL 3111	3,5 - 4,0	7,0	12,0	3,5 - 4,0
QL 3136	2,7 - 3,2	6,5	11,5	4,0 - 6,5
QL 3140	4,0 - 5,0	7,5	15,0	4,0 - 6,5
QL 3141	2,7 - 3,2	5,5	12,0	4,0 - 6,5
QL 3147	3,0 - 3,5	6,0	10,0	3,0 - 6,0
Overlap Seal				
QL 3034	2,7 - 3,0	8,0	8,5	0,0 - 1,5
QL 3054	2,8 - 3,2	5,5	10,0	4,0 - 6,0
QL 3070	2,7 - 3,0	8,0	8,0	0,0 - 1,5
QL 3097	4,0 - 5,0	7,5	18,0	3,5 - 6,0
QL 3131	2,7 - 3,0	8,0	8,0	0,0 - 1,5
QL 3136	2,7 - 3,2	6,5	11,5	4,0 - 6,5
QL 3141	2,7 - 3,2	5,5	12,0	4,0 - 6,5
Frame Seal				
QL 3004	2,7 - 3,0	6,0	10,5	3,0 - 5,0
QL 3005	2,7 - 3,0	6,0	8,0	3,4 - 5,4
QL 3006	2,7 - 3,0	6,0	13,0	5,0 - 13,0
QL 3009	2,7 - 3,0	6,0	11,0	4,0 - 7,5
QL 3011	2,7 - 3,0	6,0	10,0	3,5 - 5,5
QL 3012	2,7 - 3,0	6,0	11,0	4,0 - 6,5
QL 3013	2,7 - 3,0	6,0	8,0	2,0 - 3,0
QL 3025	2,7 - 3,0	6,0	10,5	3,0 - 5,0
QL 3037	2,7 - 3,0	6,0	10,0	3,5 - 5,6
QL 3074	2,7 - 3,2	6,5	8,5	3,5 - 5,5
QL 3077	2,7 - 3,0	6,0	8,0	2,0 - 3,0
QL 3078	3,0 - 3,3	6,0	10,5	4,0 - 7,5
QL 3082	2,7 - 3,2	5,0	8,0	3,0 - 5,0
QL 3099	3,0 - 3,3	6,0	10,5	4,0 - 7,5
QL 3118	3,0 - 3,3	7,0	9,0	3,0 - 7,5
QL 3128	2,7 - 3,0	7,0	9,0	4,0 - 7,5
QL 3139	2,7 - 3,0	7,0	9,0	4,0 - 7,5
QL 3143	2,7 - 3,0	6,0	10,5	3,0 - 5,0
QL 5271	2,7 - 3,0	6,0	11,0	2,4 - 3,8
QL 5878	2,7 - 3,0	6,0	10,0	3,2 - 4,9
QL 9985	2,7 - 3,0	6,0	10,0	3,0 - 6,5

PVCu doors

Pocket-Slot	Slot		Seal Gap
	Throat Width		
QL 9710	3,3		3,0 - 5,5
QL 9756	3,3		1,0 - 4,8
QL 9762	3,2		2,5 - 4,0
QL 9898	3,2		3,0 - 5,5
QL 9926	3,2 - 3,4		3,0 - 7,5
QL 9928	3,2 - 3,4		3,0 - 7,5

PVCu windows

Pocket-Slot	Slot		Seal Gap
	Throat Width		
QL 4465	4,2		3,0 - 4,8
QL 5570	3,3		3,0 - 4,8
QL 5985	4,0		2,3 - 3,6
QL 6493	3,6		2,0 - 3,0
QL 6571	3,0		3,0 - 5,0
QL 6750	2,5		2,6 - 4,1
QL 6991	3,9		2,0 - 3,2
QL 7032	3,0		1,5 - 5,1
QL 7307	3,2		2,8 - 4,4
QL 9005	2,4		2,5 - 4,1
QL 9100	2,4		2,7 - 4,4
QL 9112	3,2		3,0 - 4,9
QL 9154	3,2		2,8 - 4,5
QL 9257	3,2		4,5 - 7,1
QL 9489	3,4		2,5 - 4,0
QL 9596	3,4		2,5 - 4,0
QL 9646	3,6		3,5 - 5,5
QL 9688	2,8		3,0 - 7,0
QL 9710	3,3		3,0 - 5,5
QL 9756	3,3		1,0 - 4,8
QL 9762	3,2		2,5 - 4,0
QL 9898	3,2		3,0 - 5,5
QL 9926	3,2 - 3,4		3,0 - 7,5
QL 9928	3,2 - 3,4		3,0 - 7,5

PVCu and aluminium doors

T-Slot	Application Dimensions (mm)		Seal Gap
	Groove		
	Throat Width	Depth	
Type A (5,3 mm)			
QL 4870	3,2	2,3	2,5 - 4,0
QL 48100	3,2	2,3	5,5 - 7,0
QL 48447	3,2	2,3	2,5 - 7,0
QL 48700	3,2	2,3	2,5 - 6,0
QL 48800	3,2	2,3	2,5 - 7,0
QL 48950	3,2	2,3	4,0 - 6,5
Type C (7,5 mm)			
QL 6970	4,6	2,3	2,5 - 4,0
QL 69100	4,6	2,3	5,5 - 7,0
QL 69447	4,6	2,3	2,5 - 7,0
QL 69700	4,6	2,3	2,5 - 6,0
QL 69800	4,6	2,3	2,5 - 7,0
QL 69950	4,6	2,3	4,0 - 6,5

Other PVCu and aluminium applications

T-Slot	Application Dimensions (mm)		Seal Gap
	Groove		
	Throat Width	Depth	
Type A (5,3 mm)			
QL 4636	3,2	2,3	1,0 - 2,5
QL 4870	3,2	2,3	2,5 - 4,0
QL 48100	3,2	2,3	5,5 - 7,0
QL 48400	3,2	2,3	0,5 - 2,0
QL 48510	3,2	2,3	1,1 - 2,4
QL 48650	3,2	2,3	1,8 - 3,4
QL 48447	3,2	2,3	2,5 - 7,0
QL 48700	3,2	2,3	2,5 - 6,0
QL 48800	3,2	2,3	2,5 - 7,0
QL 48750	3,2	2,3	2,7 - 4,6
QL 48950	3,2	2,3	4,0 - 6,5
Type B (6,3 mm)			
QL 57700	3,8	2,3	2,3 - 4,0
Type C (7,5 mm)			
QL 6970	4,6	2,3	2,5 - 4,0
QL 69100	4,6	2,3	5,5 - 7,0
QL 69400	4,6	2,3	0,5 - 1,5
QL 69447	4,6	2,3	2,5 - 7,0
QL 69510	4,6	2,3	1,1 - 2,4
QL 69650	4,6	2,3	1,8 - 3,4
QL 69700	4,6	2,3	2,5 - 6,0
QL 69750	4,6	2,3	2,7 - 4,6
QL 69800	4,6	2,3	2,5 - 7,0
QL 69950	4,6	2,3	4,0 - 6,5

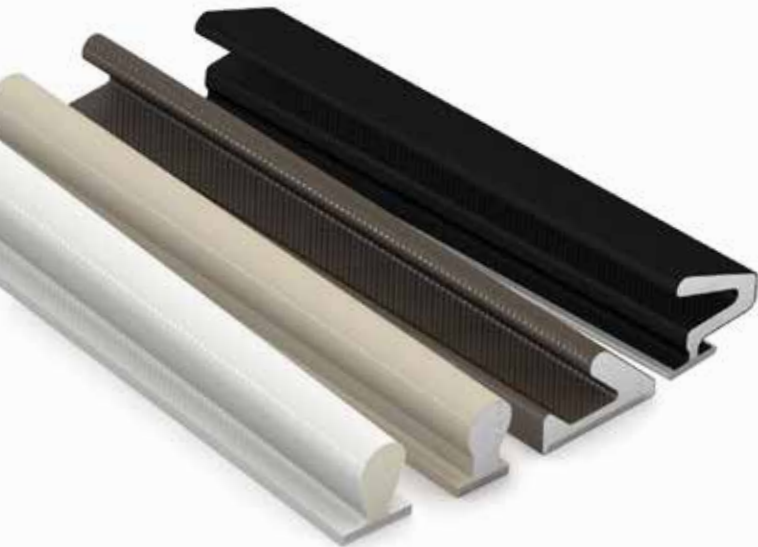

T-Slot dimensions

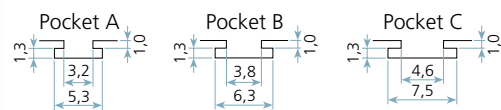

Internal doors

Kerf-Slot	Application Dimensions (mm)			
	Groove		Rebate	Seal Gap
	Throat Width	Min. Depth		
QL 50	2,7 - 3,0	6,0	10,0	3,0 - 5,0
QL 55	2,7 - 3,0	6,0	10,0	3,0 - 4,5
QL 60	2,7 - 3,0	6,0	10,0	3,0 - 4,5
QL 3037	2,7 - 3,0	6,0	10,0	3,5 - 5,6
QL 3072	2,7 - 3,2	6,5	10,0	2,7 - 4,3
QL 3091	4,0 - 5,0	7,5	15,0	4,0 - 8,0
QL 3094	2,7 - 3,2	6,5	10,0	3,0 - 6,0
QL 3100	3,5 - 4,0	6,5	12,0	4,0 - 7,5
QL 3106	3,5 - 4,0	6,5	12,0	3,0 - 5,0
QL 3110	3,5 - 4,0	6,5	12,0	3,5 - 4,0
QL 3113	3,5 - 4,0	7,0	12,0	4,0 - 7,5
QL 3137	2,7 - 3,2	6,0	10,0	3,0 - 4,5
QL 3138	2,7 - 3,2	6,0	8,0	3,0 - 4,5
QL 9915	2,7 - 3,0	6,0	11,0	2,5 - 4,5
QL 9931	3,0 - 3,5	6,5	12,0	3,5 - 4,0
QL 9985	2,7 - 3,0	6,0	10,0	3,0 - 6,5

Furniture

Kerf-Slot	Application Dimensions (mm)			
	Groove		Rebate	Seal Gap
	Throat Width	Min. Depth		
QL 3006	2,7 - 3,0	6,0		5,0 - 13,0
QL 3009	2,7 - 3,0	6,0		4,0 - 7,5
QL 3011	2,7 - 3,0	6,0		3,5 - 5,5
QL 3012	2,7 - 3,0	6,0		4,0 - 6,5
QL 3013	2,7 - 3,0	6,0		2,0 - 3,0
QL 3034	2,7 - 3,0	8,0		0,0 - 1,5
QL 3037	2,7 - 3,0	6,0		3,5 - 5,6
QL 3070	2,7 - 3,0	8,0		0,0 - 1,5
QL 3072	2,7 - 3,2	6,5		2,7 - 4,3
QL 3073	4,0 - 5,0	7,5		5,0 - 8,0
QL 3074	2,7 - 3,2	6,5		3,5 - 5,5
QL 3077	2,7 - 3,0	6,0		2,0 - 3,0
QL 3078	3,0 - 3,3	6,0		4,0 - 7,5
QL 3079	3,2 - 4,0	6,5		2,7 - 4,3
QL 3091	4,0 - 5,0	7,5		4,0 - 8,0
QL 3093	2,7 - 3,0	7,0		4,0 - 8,0
QL 3094	2,7 - 3,2	6,5		3,0 - 6,0
QL 3095	3,5 - 4,0	6,5		3,0 - 6,0
QL 3096	4,0 - 5,0	7,5		3,0 - 6,0
QL 3098	3,0 - 4,0	7,5		3,0 - 6,0
QL 3099	3,0 - 3,3	6,0		4,0 - 7,5
QL 3100	3,5 - 4,0	6,5		4,0 - 7,5
QL 3102	3,7 - 4,2	7,0		5,0 - 7,5
QL 3104	4,0 - 5,0	7,5		5,0 - 9,0
QL 3106	3,5 - 4,0	6,5		3,0 - 5,0
QL 3109	4,0 - 5,0	7,0		5,0 - 9,0
QL 3110	3,5 - 4,0	6,5		3,5 - 4,0
QL 3113	3,5 - 4,0	7,0		4,0 - 7,5
QL 3118	3,0 - 3,3	7,0		3,0 - 7,5
QL 3128	2,7 - 3,0	7,0		4,0 - 7,5
QL 3131	2,7 - 3,0	8,0		0,0 - 1,5
QL 3137	2,7 - 3,2	6,0		3,0 - 4,5
QL 3138	2,7 - 3,2	6,0		3,0 - 4,5
QL 3139	2,7 - 3,0	7,0		4,0 - 7,5
QL 5626	2,7 - 3,0	6,0		4,7 - 7,5
QL 5694	2,7 - 3,0	6,0		6,0 - 11,0
QL 7000	2,7 - 3,0	6,0		4,0 - 10,8
QL 7066	2,7 - 3,0	6,0		4,8 - 7,7
QL 9111	3,0 - 3,3	6,0		4,8 - 7,9
QL 9915	2,7 - 3,0	6,0		2,5 - 4,5
QL 9931	3,0 - 3,5	6,5		3,5 - 4,0
QL 9985	2,7 - 3,0	6,0		3,0 - 6,5

Q-Lon Polyurethane Foam Seals: for universal surface fitting



- Universal – direct application on a flat surface
- Fixing with pre-applied adhesive tape
- Alternatively it can be fixed with adhesive tape, hot melt glue or staples
- Available colours: white, black, bronze and grey.
Other colours available on request

QL 3042 (AQ 6150)

Untaped

Width: 11,2

Height: 6,5

Rebate: 11,0

Seal gap: 3,0 - 5,5

Packaging:
400 m x 2

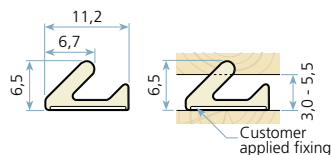

W24265

QL 3059

Untaped

Width: 10,8

Height: 8,7

Rebate: 11,0

Seal gap: 3,0 - 5,5

Packaging:
300 m x 2

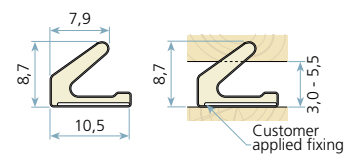

W33265

QL 3061

Untaped

Width: 15,0
Height: 12,0
Rebate: 15,0
Seal gap: 5,0 - 10,0
Packaging:
250 m x 2

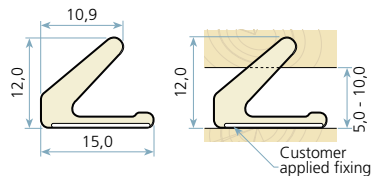

W43265

QL 1026

Taped

Width: 12,0
Height: 4,0
Rebate: 12,0
Seal gap: 1,0 - 3,0
Packaging:
250 m x 2 / 500 m x 2

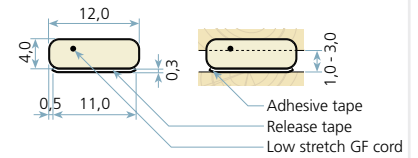

W26275

QL 1032

Taped

Width: 12,0
Height: 7,0
Rebate: 12,0
Seal gap: 2,0 - 6,0
Packaging:
250 m x 2 / 500 m x 2

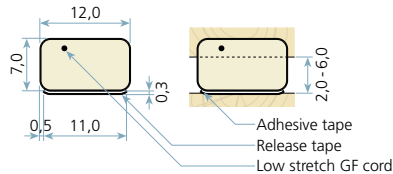

W35275

QL 3015

(AQ 122)

Taped

Width: 8,0
Height: 5,0
Rebate: 8,0
Seal gap: 2,5 - 4,0
Packaging:
500 m x 2

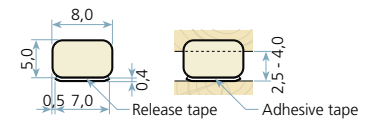

QL 3116

Taped

Width: 10,8
Height: 8,7
Rebate: 11,0
Seal gap: 3,0 - 5,5
Packaging:
300 m x 2

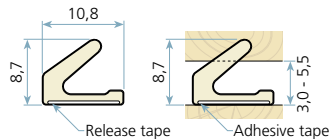

W44265

QL 3117

Taped

Width: 11,2
Height: 6,5
Rebate: 11,0
Seal gap: 3,0 - 5,5
Packaging:
400 m x 2

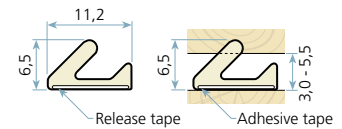

W23265

QL 3121

Taped

Width: 15,0
Height: 12,0
Rebate: 15,0
Seal gap: 5,0 - 10,0
Packaging:
225 m x 2

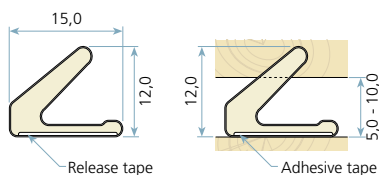

W42265

QL 3122

Taped

Width: 7,0
Height: 2,2
Rebate: 7,0
Seal gap: 0,5 - 2,0
Packaging:
200 m x 2

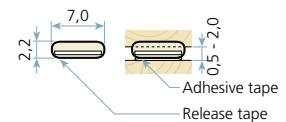

W17275

QL 3124

Taped

Width: 6,4
Height: 3,7
Rebate: 6,0
Seal gap: 2,5 - 3,5
Packaging:
1000 m x 2

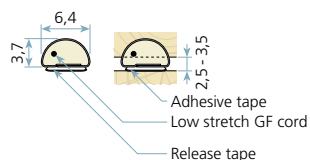

W16275

QL 3126

Taped

Width: 10,0
Height: 3,0
Rebate: 10,0
Seal gap: 1,0 - 2,5
Packaging:
700 m x 2

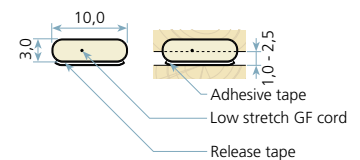

W17275



- Efficient processing – right from the coil, no waste
- Suitable for automatic insertion or fixing
- Compatible with all paints and glazes, including acrylic paints
- Available colours: white, black, bronze and grey. Other colours available on request

Q-Lon Polyurethane Foam Seals:

for timber window and entry door applications

Specifically designed for timber windows and entry doors, Q-Lon foam seals combine the best thermal performance along with good soundproofing properties across a wide temperature range. Very low operating forces reduce wear and tear and give ease of operation.

Testing and results

Compression set:	< 15% after 1 hour relief of 50% compression at 70 °C and 24 hours (DIN 53572)
Compression force:	approx. 15 N at 25% compression per 100 mm, < 10 N for lip profiles
Tested temperature range:	-60 °C to +70 °C
Heat conductivity:	0,041 W/mK at 0 °C
Long life performance:	no change of the length-related and partial joint permeability
Environment testing:	tested and passed pursuant to DIN 18055, EN 12207 and EN 12208 to 600 Pa at single and French window
Paint compatibility:	no adhesion, no hardening, no discolouration
Acoustic testing:	43 dB at a window IV68 with a centre seal 45 dB at a window IV76 with centre and overlap seals
Weather-resistant:	tested up to 20 years



For timber window and entry doors

QL 3004 (AQ 99)

Windows

Groove width:
2,7 - 3,0

Min. groove
depth: 6,0

Rebate: 10,5

Seal gap: 3,0 - 5,0

Packaging: 350 m x 2

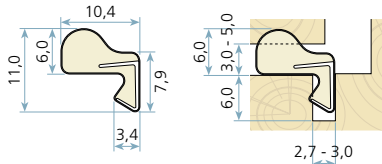

F

W26275

QL 3005 (AQ 63)

Windows

Groove width:
2,7 - 3,0

Min. groove
depth: 6,0

Rebate: 8,0

Seal gap: 3,4 - 5,4

Packaging: 300 m x 2

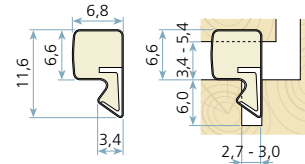

F

W35265

QL 3006 (AQ 89)

Windows

Groove width:
2,7 - 3,0

Min. groove
depth: 6,0

Rebate: 13,0

Seal gap: 5,0 - 13,0

Packaging: 2,1 m x 150

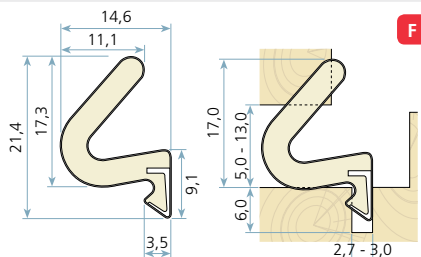

F

W62275

QL 3009 (AQ 21)

Entry doors / Windows

Groove width:
2,7 - 3,0

Min. groove
depth: 6,0

Rebate: 11,0

Seal gap: 4,0 - 7,5

Packaging: 250 m x 2

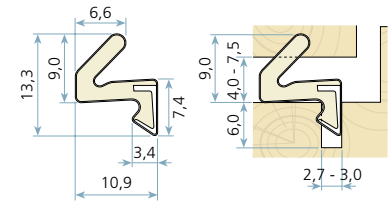

F

W32265

QL 3011 (AQ 109)

Windows

Groove width:
2,7 - 3,0

Min. groove
depth: 6,0

Rebate: 10,0

Seal gap: 3,5 - 5,5

Packaging: 250 m x 2

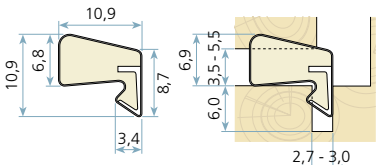

F

W35275

QL 3012 (AQ 33)

Windows

Groove width:
2,7 - 3,0

Min. groove
depth: 6,0

Rebate: 11,0

Seal gap: 4,0 - 6,5

Packaging: 200 m x 2

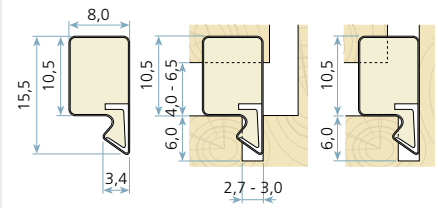

F

W45275

QL 3013 (AQ 48)

Windows

Groove width:
2,7 - 3,0

Min. groove
depth: 6,0

Rebate: 8,0

Seal gap: 2,0 - 3,0

Packaging: 500 m x 2

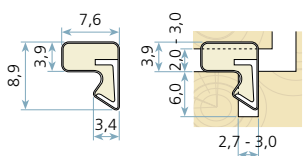

F

S

W15275

QL 3020 (AQ 120)

Entry doors

Groove width:
2,7 - 3,0

Min. groove
depth: 7,0

Rebate: 13,0

Seal gap: 3,5 - 7,5

Packaging: 125 m x 2

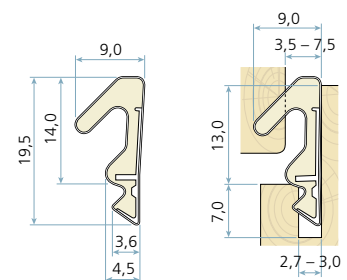

QL 3025

Windows

Groove width:
2,7 - 3,0

Min. groove
depth: 6,0

Rebate: 10,5

Seal gap: 3,0 - 5,0

Packaging: 350 m x 2

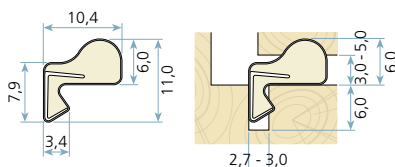

F

W25265

QL 3034

Windows

Groove width:
2,7 - 3,0

Min. groove
depth: 8,0

Rebate: 8,5

Seal gap: 0,0 - 1,5

Packaging: 400 m x 2

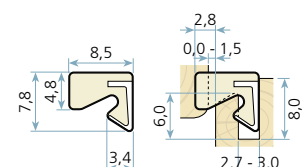

O

S

W36276

For timber window and entry doors

QL 3037 (AQ 4846)

Windows

Groove width:
2,7 - 3,0

Min. groove
depth: 6,0

Rebate: 10,0

Seal gap: 3,5 - 5,6

Packaging: 200 m x 2

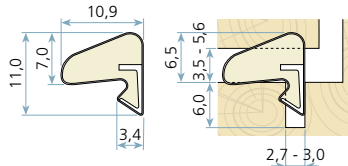

F

W35265

QL 3053

Entry doors / Windows

Groove width:
4,0 - 5,0

Min. groove
depth: 7,5

Rebate: 12,0

Seal gap: 4,5 - 6,0

Packaging: 200 m x 2

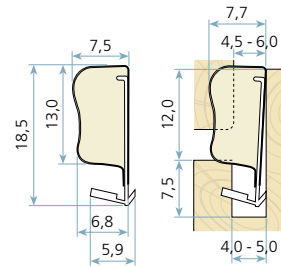

C

S

W35265

QL 3054

Windows

Groove width:
2,8 - 3,2

Min. groove
depth: 5,5

Rebate: 10,0

Seal gap: 4,0 - 6,0

Packaging: 250 m x 2

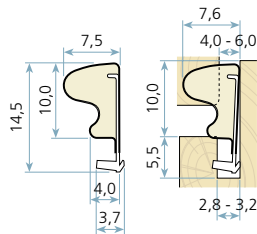

O

W35275

QL 3063

Windows

Groove width:
4,0 - 5,0

Min. groove
depth: 7,5

Rebate: 12,0

Seal gap: 5,5 - 7,5

Packaging: 200 m x 2

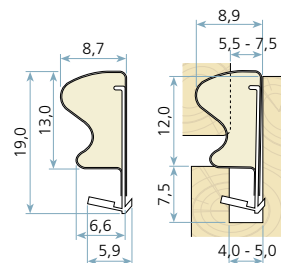

C

S

W36265

QL 3067 (AQ 5104)

Windows

Groove width:
4,0 - 5,0

Min. groove
depth: 7,5

Rebate: 12,0

Seal gap: 4,0 - 6,0

Packaging: 200 m x 2

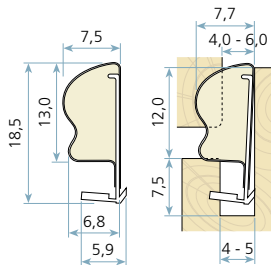

C

S

W35275

QL 3068

Windows

Groove width:
3,4 - 4,2

Min. groove
depth: 6,5

Rebate: 11,0

Seal gap: 4,5 - 6,5

Packaging: 200 m x 2

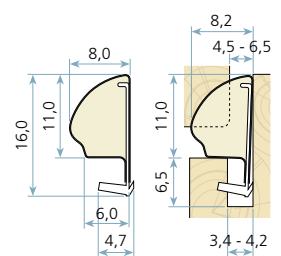

C

S

W35275

QL 3070

Windows

Groove width:
2,7 - 3,0

Min. groove
depth: 8,0

Rebate: 8,0

Seal gap: 0,0 - 1,5

Packaging: 400 m x 2

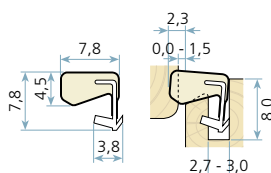

O

S

W25275

QL 3072

Windows

Groove width:
2,7 - 3,2

Min. groove
depth: 6,5

Rebate: 10,0

Seal gap: 2,7 - 4,3

Packaging: 300 m x 2

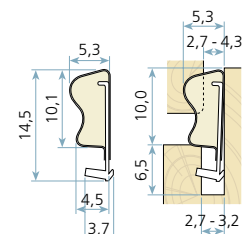

C

S

W24265

QL 3073

Entry doors

Groove width:
4,0 - 5,0

Min. groove
depth: 7,5

Rebate: 13,0

Seal gap: 5,0 - 8,0

Packaging:
150 m x 2 / 200 m x 2

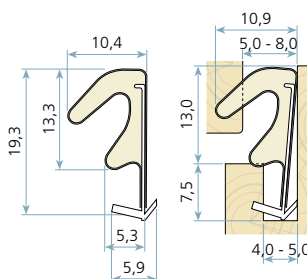

F

W44275

QL 3074

Windows

Groove width:
2,7 - 3,2

Min. groove
depth: 6,5

Rebate: 8,5

Seal gap: 3,5 - 5,5

Packaging: 300 m x 2

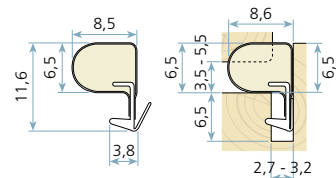

F

For timber window and entry doors

QL 3076

Windows

Groove width:
3,0 - 3,5
Min. groove
depth: 6,0
Rebate: 10,0
Seal gap: 3,0 - 6,0
Packaging: 250 m x 2

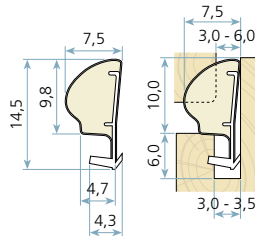

C

W34265

QL 3077

Windows

Groove width:
2,7 - 3,0
Min. groove
depth: 6,0
Rebate: 8,0
Seal gap: 2,0 - 3,0
Packaging: 500 m x 2

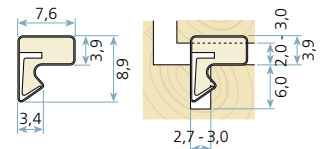

F

S

W15275

QL 3078

Entry doors / Windows

Groove width:
3,0 - 3,3
Min. groove
depth: 6,0
Rebate: 10,5
Seal gap: 4,0 - 7,5
Packaging:
250 m x 2 / 300 m x 2

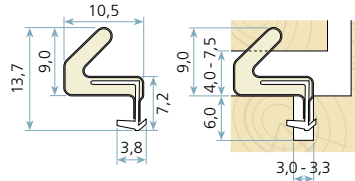

F

W33265

QL 3079

Entry doors / Windows

Groove width:
3,2 - 4,0
Min. groove
depth: 6,5
Rebate: 10,0
Seal gap: 2,7 - 4,3
Packaging: 300 m x 2

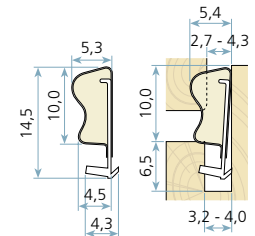

C

S

W24265

QL 3082

Windows

Groove width:
2,7 - 3,2
Min. groove
depth: 5,0
Rebate: 8,0
Seal gap: 3,0 - 5,0
Packaging: 250 m x 2

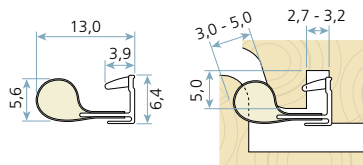

F

W35275

QL 3091

Entry doors

Groove width:
4,0 - 5,0
Min. groove
depth: 7,5
Rebate: 15,0
Seal gap: 4,0 - 8,0
Packaging:
150 m x 2 / 400 m x 1

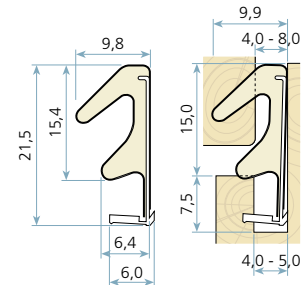

C

S

W44265

QL 3093

Entry doors

Groove width:
2,7 - 3,0
Min. groove
depth: 7,0
Rebate: 13,0
Seal gap: 4,0 - 8,0
Packaging:
150 m x 2 / 400 m x 1

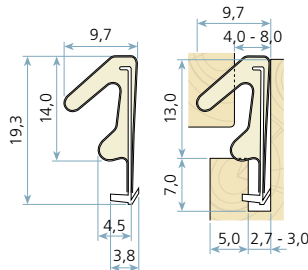

W34265

QL 3094

Entry doors

Groove width:
2,7 - 3,2
Min. groove
depth: 6,5
Rebate: 10,0
Seal gap: 3,0 - 6,0
Packaging: 250 m x 2

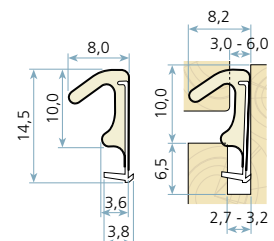

W32265

QL 3095

Entry doors

Groove width:
3,5 - 4,0
Min. groove
depth: 6,5
Rebate: 10,0
Seal gap: 3,0 - 6,0
Packaging: 250 m x 2

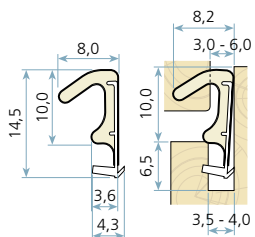

W32275

QL 3096

Entry doors

Groove width:
4,0 - 5,0
Min. groove
depth: 7,5
Rebate: 12,0
Seal gap: 3,0 - 6,0
Packaging: 200 m x 2

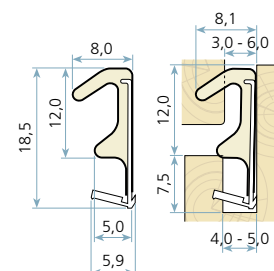

W33265

For timber window and entry doors

QL 3097

Entry doors / Windows

Groove width: 4,0 - 5,0
 Min. groove depth: 7,5
 Rebate: 18,0
 Seal gap: 3,5 - 6,0
 Packaging: 150 m x 2

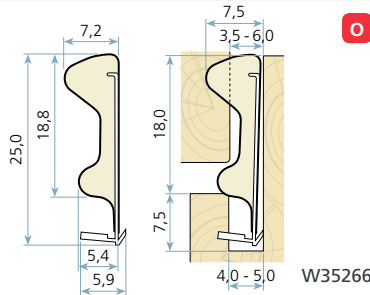

O

QL 3098

Entry doors

Groove width: 3,0 - 4,0
 Min. groove depth: 7,5
 Rebate: 14,0
 Seal gap: 3,0 - 6,0
 Packaging: 150 m x 2

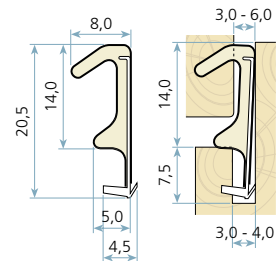

W33265

QL 3099

Entry doors / Windows

Groove width: 3,0 - 3,3
 Min. groove depth: 6,0
 Rebate: 10,5
 Seal gap: 4,0 - 7,5
 Packaging: 250 m x 2 / 300 m x 2

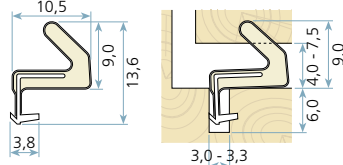

F

QL 3101

Windows

Groove width: 2,7 - 3,2
 Min. groove depth: 7,0
 Rebate: 13,0
 Seal gap: 3,5 - 6,0
 Packaging: 200 m x 2

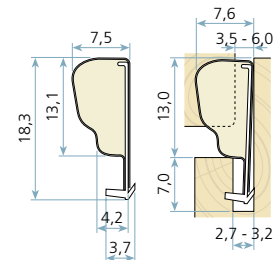

C

QL 3102

Entry doors

Groove width: 3,7 - 4,2
 Min. groove depth: 7,0
 Rebate: 11,0
 Seal gap: 5,0 - 7,5
 Packaging: 200 m x 2

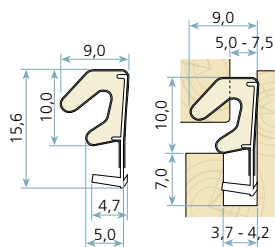

W33265

QL 3104

Entry doors

Groove width: 4,0 - 5,0
 Min. groove depth: 7,5
 Rebate: 12,0
 Seal gap: 5,0 - 9,0
 Packaging: 200 m x 2

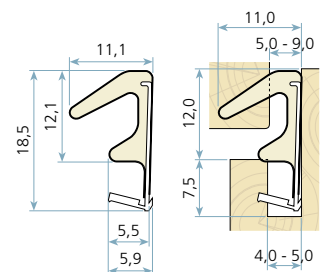

W44275

QL 3109

Entry doors

Groove width: 4,0 - 5,0
 Min. groove depth: 7,0
 Rebate: 18,0
 Seal gap: 5,0 - 9,0
 Packaging: 100 m x 2

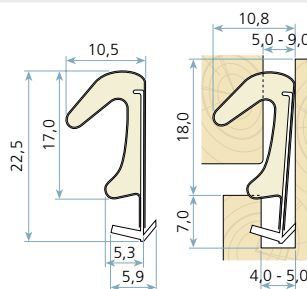

W43275

QL 3111

Windows

Groove width: 3,5 - 4,0
 Min. groove depth: 7,0
 Rebate: 12,0
 Seal gap: 3,5 - 4,0
 Packaging: 200 m x 2

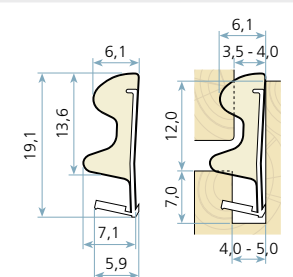

W35255

C

S

QL 3118

Entry doors / Windows

Groove width: 3,0 - 3,3
 Min. groove depth: 7,0
 Rebate: 9,0
 Seal gap: 3,0 - 7,5
 Packaging: 300 m x 2

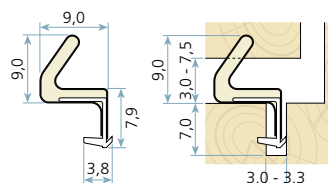

F

W32275

QL 3128

Windows

Groove width: 2,7 - 3,0
 Min. groove depth: 7,0
 Rebate: 9,0
 Seal gap: 4,0 - 7,5
 Packaging: 300 m x 2

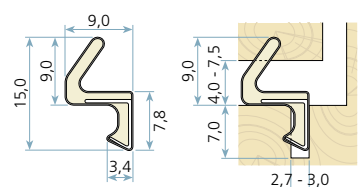

W32265

F

For timber window and entry doors

QL 3131

Windows

Groove width:
2,7 - 3,0

Min. groove
depth: 8,0

Rebate: 8,0

Seal gap: 0,0 - 1,5

Packaging: 400 m x 2

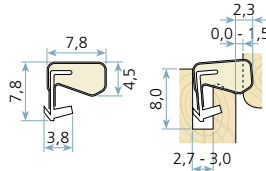

W25265

QL 3136

Windows

Groove width:
2,7 - 3,2

Min. groove
depth: 6,5

Rebate: 11,5

Seal gap: 4,0 - 6,5

Packaging: 200 m x 2

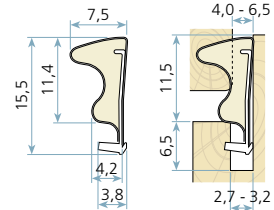

QL 3139

Windows

Groove width:
3,0 - 3,3

Min. groove
depth: 7,0

Rebate: 9,0

Seal gap: 3,0 - 7,5

Packaging: 300 m x 2

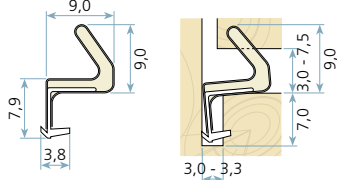

W31275

QL 3140

Windows

Groove width:
4,0 - 5,0

Min. groove
depth: 7,5

Rebate: 15,0

Seal gap: 4,0 - 6,5

Packaging: 200 m x 2

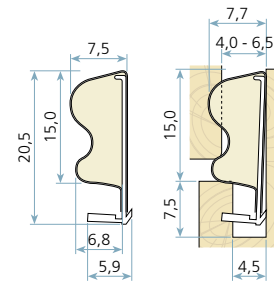

W35265

QL 3141

Windows

Groove width:
2,7 - 3,2

Min. groove
depth: 5,5

Rebate: 12,0

Seal gap: 4,0 - 6,5

Packaging: 300 m x 2

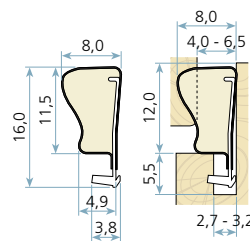

W35255 / W24255

QL 3143

Windows

Groove width:
2,7 - 3,0

Min. groove
depth: 6,0

Rebate: 10,5

Seal gap: 3,0 - 5,0

Packaging: 350 m x 2

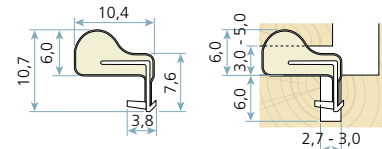

W26275

QL 3147

Windows

Groove width:
3,0 - 3,5

Min. groove
depth: 6,0

Rebate: 10,0

Seal gap: 3,0 - 6,0

Packaging: 250 m x 2

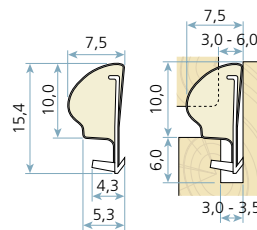

W34265

QL 5271 (AQ 5271)

Windows

Groove width:
2,7 - 3,0

Min. groove
depth: 6,0

Rebate: 11,0

Seal gap: 2,4 - 3,8

Packaging: 250 m x 2

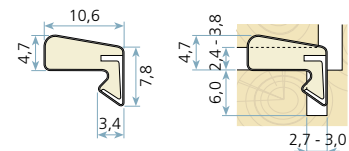

W25265

QL 5694 (AQ 5694)

Entry doors

Groove width:
2,7 - 3,0

Min. groove
depth: 6,0

Rebate: 10,0

Seal gap: 6,0 - 11,0

Packaging:
200 m x 2 / 400 m x 1

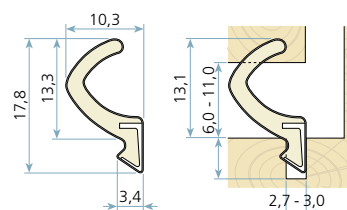

QL 5878 (AQ 5878)

Windows

Groove width:
2,7 - 3,0

Min. groove
depth: 6,0

Rebate: 10,0

Seal gap: 3,2 - 4,9

Packaging: 250 m x 2

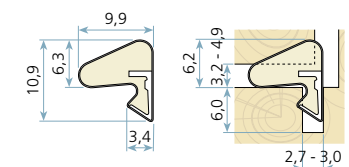

W25245

For timber window and entry doors

QL 7000

Entry doors

Groove width:

2,7 - 3,0

Min. groove

depth: 6,0

Rebate: 13,0

Seal gap: 4,0 - 10,8

Packaging: 175 m x 2

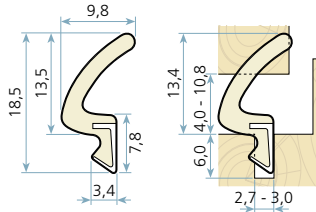

QL 7066

(AQ 7066)

Entry doors

Groove width:

2,7 - 3,0

Min. groove

depth: 6,0

Rebate: 10,0

Seal gap: 4,8 - 7,7

Packaging:

400 m x 2 / 800 m x 2

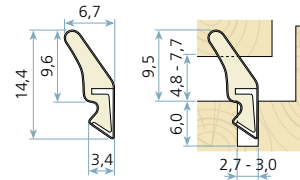

W33265

QL 9111

(AQ 9111)

Entry doors

Groove width:

3,0 - 3,3

Min. groove

depth: 6,0

Rebate: 12,0

Seal gap: 4,8 - 7,9

Packaging: 300 m x 2

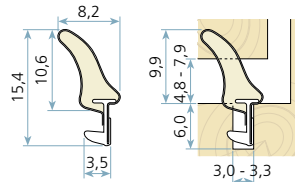

W34265

QL 9985

Windows

Groove width:

2,7 - 3,0

Min. groove

depth: 6,0

Rebate: 10,0

Seal gap: 3,0 - 6,5

Packaging: 250 m x 2

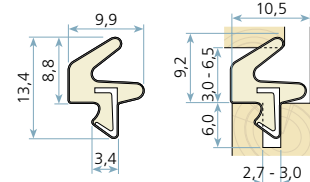

F



- Quick processing without corner cutting
- Not siliconised, neutral smell and no discolouration
- Low closing forces – low friction
- Available colours: white, black and grey. Other colours available on request

Q-Lon Polyurethane Foam Seals: for PVCu window and door and window covering product applications

Specifically designed to meet the different demands of PVCu casement windows, Schlegel Q-Lon foam seals maintain consistently high standards of energy efficiency, often exceeding any long-term window performance guarantees.

The variety of flexible shapes and different colours makes these Q-Lon profiles particularly suited for sealing applications in window covering products such as roller shutters and screens. Fitted into PVCu profiles, Q-Lon polyurethane foam seals generate noise dampening effects and help to minimise light and air leaks.

Testing and results

Tested temperature range:	-60 °C to +70 °C
Heat conductivity:	0,041 W/mK at 0 °C
Compression force:	approx. 15 N at 25% compression per 100 mm, < 10 N for lip profiles
Compression set:	< 15% after 30 minutes relief of 50% compression at 70 °C and 24 hours (EN ISO 1856)
Weather resistance:	tested up to 20 years
Ozone resistance:	crack stage 0
Abrasion resistance:	no abrasion after 285,000 cycles of grinding load
Compatibility:	compatible with PVCu, no crack formation in the contact material
Colour fastness:	no contact discolouration (colour fastness index >4)



QL 4465

Doors / Windows
Pocket-Slot

Throat width: 4,2
Min. groove
depth: 5,7
Seal gap: 3,0 - 4,8
Packaging: 250 m x 2

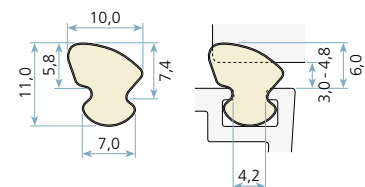

W25265

QL 4636

Windows
T-Slot
Type A (5,3 mm)

Retention slot
throat: 3,2
Min. slot depth: 2,3
Seal gap: 1,0 - 2,5
Packaging: 300 m x 2

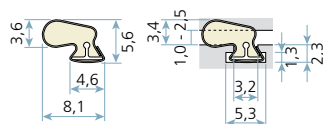

QL 4870

Doors / Windows
T-Slot
Type A (5,3 mm)

Retention slot
throat: 3,2
Min. slot depth: 2,3
Seal gap: 2,5 - 4,0
Packaging: 250 m x 2

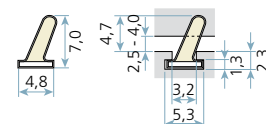

For PVCu applications

QL 5570

Windows Pocket-Slot

Throat width: 3,3

Min. groove
depth: 5,5

Seal gap: 3,0 - 4,8

Packaging: 250 m x 2

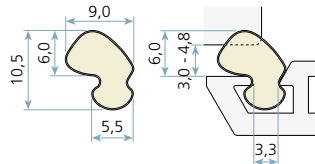

W24265

QL 5985

Windows Pocket-Slot

Throat width: 4,0

Min. groove
depth: 5,2

Seal gap: 2,3 - 3,6

Packaging: 250 m x 2

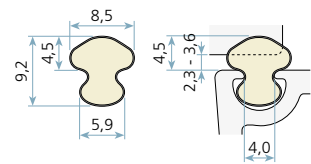

W24275

QL 6493

Windows Pocket-Slot

Throat width: 3,6

Min. groove
depth: 5,7

Seal gap: 2,0 - 3,0

Packaging: 300 m x 2

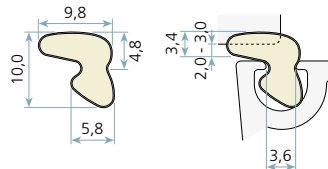

QL 6571

Windows Pocket-Slot

Throat width: 3,0

Min. groove
depth: 4,9

Seal gap: 3,0 - 5,0

Packaging: 250 m x 2

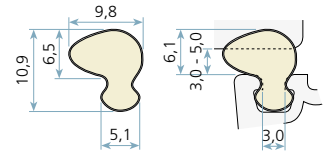

W35265

QL 6750

Windows Pocket-Slot

Throat width: 2,5

Min. groove
depth: 4,9

Seal gap: 2,6 - 4,1

Packaging: 300 m x 2

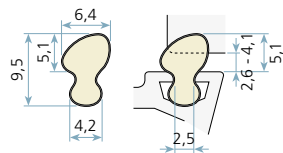

W34265

QL 6970

Doors / Windows T-Slot Type C (7,5 mm)

Retention slot
throat: 4,6

Min. slot depth: 2,3

Seal gap: 2,5 - 4,0

Packaging: 250 m x 2

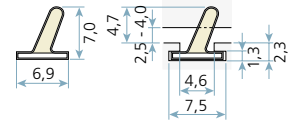

QL 6991

Windows Pocket-Slot

Throat width: 3,9

Min. groove
depth: 5,3

Seal gap: 2,0 - 3,2

Packaging:
250 m x 2 / 300 m x 2

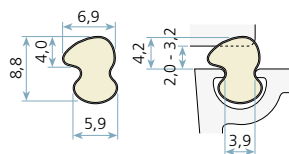

W35276

QL 7032

Doors / Windows Pocket-Slot

Throat width: 3,0

Min. groove
depth: 4,5

Seal gap: 1,5 - 5,1

Packaging:
200 m x 2 / 400 m x 2

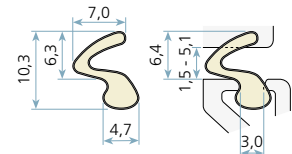

QL 7307

Windows Pocket-Slot

Throat width: 3,2

Min. groove
depth: 4,8

Seal gap: 2,8 - 4,4

Packaging: 250 m x 2

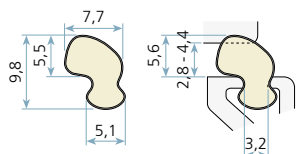

QL 9005

Windows Pocket-Slot

Throat width: 2,4

Min. groove
depth: 5,2

Seal gap: 2,5 - 4,1

Packaging:
100 m x 2 / 300 m x 2
400 m x 2

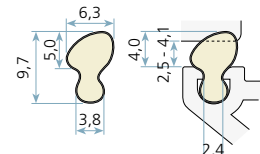

W24265

For PVCu applications

QL 9100

Windows Pocket-Slot

Throat width: 2,4
Min. groove
depth: 5,3
Seal gap: 2,7 - 4,4
Packaging: 250 m x 2

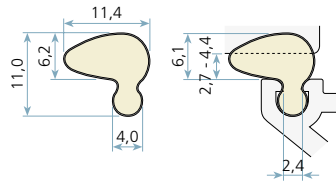

W35275

QL 9112

Windows Pocket-Slot

Throat width: 3,2
Min. groove
depth: 4,8
Seal gap: 3,0 - 4,9
Packaging: 300 m x 2

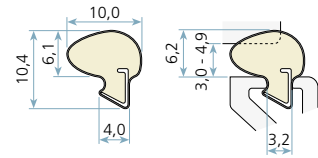

W35275

QL 9154

Windows Pocket-Slot

Throat width: 3,2
Min. groove
depth: 4,7
Seal gap: 2,8 - 4,5
Packaging: 300 m x 2 / 600 m x 1

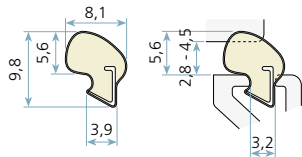

W35265

QL 9257

Doors / Windows Pocket-Slot

Throat width: 3,2
Min. groove
depth: 4,4
Seal gap: 4,5 - 7,1
Packaging: 300 m x 2

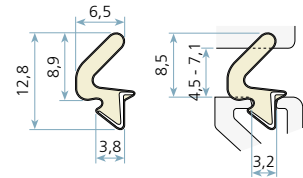

QL 9489

Doors / Windows Pocket-Slot

Throat width: 3,4
Min. groove
depth: 4,0
Seal gap: 2,5 - 4,0
Packaging: 250 m x 2

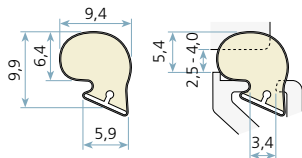

W36275

QL 9536

Doors Pocket-Slot

Throat width: 3,9
Min. groove
depth: 6,3
Seal gap: 4,0 - 8,0
Packaging: 250 m x 2

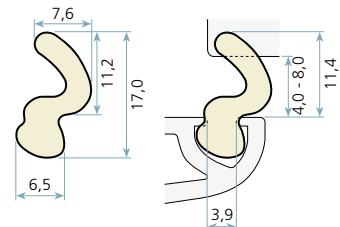

W43275

QL 9596

Windows Pocket-Slot

Throat width: 3,4
Min. groove
depth: 5,2
Seal gap: 2,5 - 4,0
Packaging: 300 m x 2

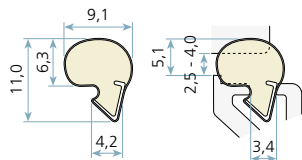

W36275

QL 9646

Windows Pocket-Slot

Throat width: 3,6
Min. groove
depth: 5,1
Seal gap: 3,5 - 5,5
Packaging: 250 m x 2

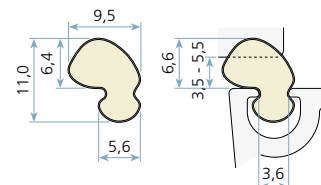

W35275

QL 9688

Doors / Windows Pocket-Slot

Throat width: 2,8
Min. groove
depth: 3,9
Seal gap: 3,0 - 7,0
Packaging: 400 m x 2

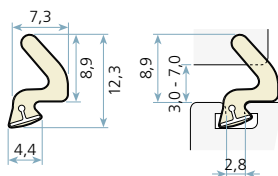

W33275

QL 9710

Windows Pocket-Slot

Throat width: 3,3
Min. groove
depth: 5,0
Seal gap: 3,0 - 5,5
Packaging: 300 m x 2

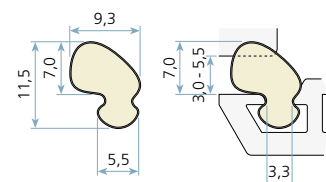

For PVCu applications

QL 9756

Windows
Pocket-Slot

Throat width: 3,3

Min. groove
depth: 5,0

Seal gap: 1,0 - 4,8

Packaging: 300 m x 2

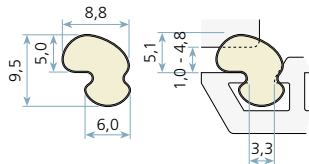

W25275

QL 9762

Windows
Pocket-Slot

Throat width: 3,2

Min. groove
depth: 4,5

Seal gap: 2,5 - 4,0

Packaging:
300 m x 2 / 700 m x 2

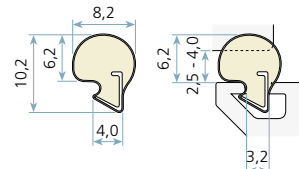

W35275

QL 9898

Windows
Pocket-Slot

Throat width: 3,2

Min. groove
depth: 4,9

Seal gap: 3,0 - 5,5

Packaging:
300 m x 2 / 700 m x 2

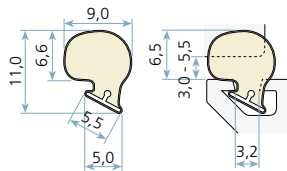

W35275

QL 9926

Doors / Windows
Pocket-Slot

Throat width:
3,2 - 3,4

Min. groove
depth: 5,0

Seal gap: 3,0 - 7,5

Packaging: 300 m x 2

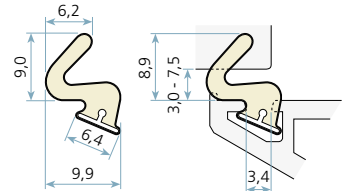

W33275

QL 9928

Doors / Windows
Pocket-Slot

Throat width:
3,2 - 3,4

Min. groove
depth: 3,9

Seal gap: 3,0 - 7,5

Packaging: 300 m x 2

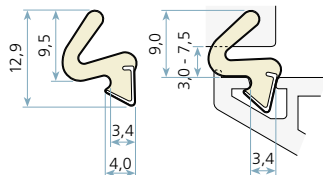

W34275

QL 48100

Doors / Windows
T-Slot

Type A (5,3 mm)

Retention slot
throat: 3,2

Min. slot depth: 2,3

Seal gap: 5,5 - 7,0

Packaging: 250 m x 2

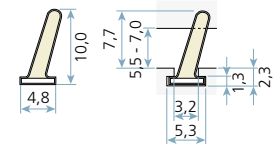

QL 48447

Doors / Windows
T-Slot

Type A (5,3 mm)

Throat width: 3,2

Groove depth: 2,3

Seal gap: 2,5 - 7,0

Packaging: 250 m x 2

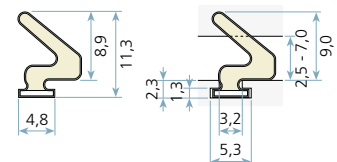

W33265

QL 48400

Windows
T-Slot
Type A (5,3 mm)

Throat width: 3,2

Groove depth: 2,3

Seal gap: 0,5 - 1,5

Packaging:
200 m x 2 / 700 m x 2
900 m x 2

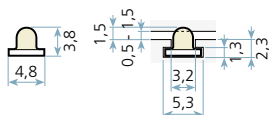

QL 48510

Windows
T-Slot
Type A (5,3 mm)

Throat width: 3,2

Groove depth: 2,3

Seal gap: 1,1 - 2,4

Packaging:
200 m x 2 / 500 m x 2
900 m x 2

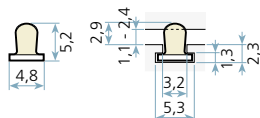

QL 48650

Windows
T-Slot
Type A (5,3 mm)

Throat width: 3,2

Groove depth: 2,3

Seal gap: 1,8 - 3,4

Packaging:
200 m x 2 / 500 m x 2
700 m x 2

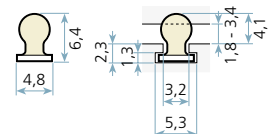

W25255

For PVCu applications

QL 48700

Doors / Windows
T-Slot
Type A (5,3 mm)
Throat width: 3,2
Groove depth: 2,3
Seal gap: 2,5 - 6,0
Packaging: 250 m x 2

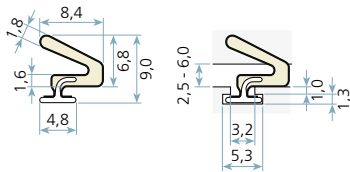

W33275

QL 48750

Windows
T-Slot
Type A (5,3 mm)
Throat width: 3,2
Groove depth: 2,3
Seal gap: 2,7 - 4,6
Packaging: 200 m x 2 / 600 m x 2

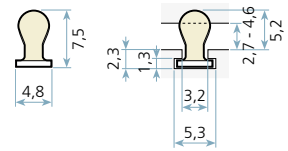

W25265

QL 48800

Doors / Windows
T-Slot
Type A (5,3 mm)
Throat width: 3,2
Groove depth: 2,3
Seal gap: 2,5 - 7,0
Packaging: 250 m x 2

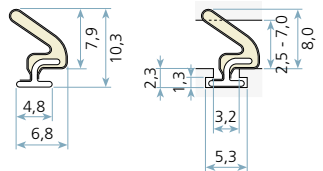

W34275

QL 48950

Doors / Windows
T-Slot
Type A (5,3 mm)
Throat width: 3,2
Groove depth: 2,3
Seal gap: 4,0 - 6,5
Packaging: 200 m x 2 / 500 m x 2

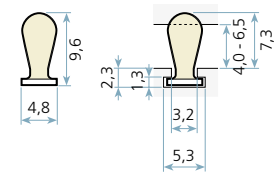

W34265

QL 57700

Windows
T-Slot
Type B (6,3 mm)
Throat width: 3,8
Groove depth: 2,3
Seal gap: 2,3 - 4,0
Packaging: 200 m x 2 / 500 m x 2

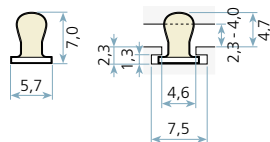

QL 69100

Doors / Windows
T-Slot
Type C (7,5 mm)
Retention slot throat: 4,6
Min. slot depth: 2,3
Seal gap: 5,5 - 7,0
Packaging: 250 m x 2

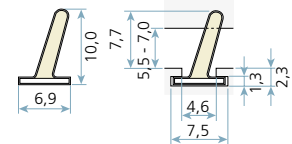

QL 69400

Windows
T-Slot
Type C (7,5 mm)
Throat width: 4,6
Groove depth: 2,3
Seal gap: 0,5 - 1,5
Packaging: 200 m x 2 / 700 m x 2
900 m x 2

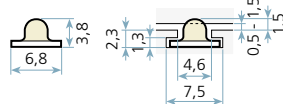

QL 69447

Doors / Windows
T-Slot
Type C (7,5 mm)
Throat width: 4,6
Groove depth: 2,3
Seal gap: 2,5 - 7,0
Packaging: 250 m x 2

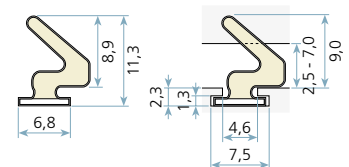

W33265

QL 69510

Windows
T-Slot
Type C (7,5 mm)
Throat width: 4,6
Groove depth: 2,3
Seal gap: 1,1 - 2,4
Packaging: 700 m x 2

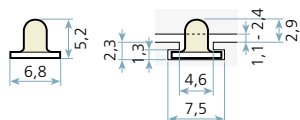

W15245

QL 69650

Windows
T-Slot
Type C (7,5 mm)
Throat width: 4,6
Groove depth: 2,3
Seal gap: 1,8 - 3,4
Packaging: 200 m x 2 / 400 m x 2
600 m x 2

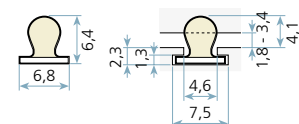

W25265

For PVCu applications

QL 69700

Doors / Windows
T-Slot
Type C (7,5 mm)
Retention slot
throat: 4,6
Min. slot depth: 2,3
Seal gap: 2,5 - 6,0
Packaging: 250 m x 2

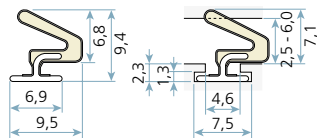

W33275

QL 69750

Windows
T-Slot
Type C (7,5 mm)
Throat width: 4,6
Groove depth: 2,3
Seal gap: 2,7 - 4,6
Packaging:
200 m x 2 / 500 m x 2

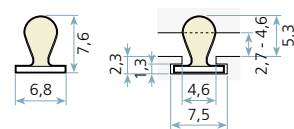

W24265

QL 69800

Doors / Windows
T-Slot
Type C (7,5 mm)
Throat width: 4,6
Groove depth: 2,3
Seal gap: 2,5 - 7,0
Packaging: 250 m x 2

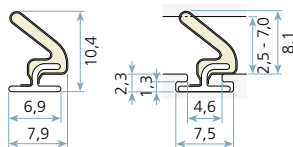

W34265

QL 69950

Doors / Windows
T-Slot
Type C (7,5 mm)
Throat width: 4,6
Groove depth: 2,3
Seal gap: 4,0 - 6,5
Packaging:
200 m x 2 / 350 m x 2

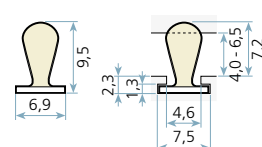

W34265

T-Slot dimensions

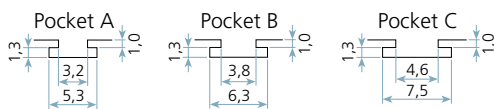

Case Study:

BFK, Novosibirsk, Siberia

BFK produce windows from VEKA PVCu profiles and have specified Schlegel Q-Lon PU foam seals QL 4465 and QL 9756 as sash and frame seals.

BFK windows have been installed in apartments in Krasnoyarsk, Siberia, about 4,000 km to the East of Moscow, where winter temperatures are between -20 and -50 °C.

BFK explained:

“Compared with other sealing types, Schlegel Q-Lon seals remain flexible and therefore perform better, especially in the winter period. This was confirmed by tests at the BFK laboratory. Q-Lon seal QL 9756 was especially developed in coordination with the BFK engineering team.”

Fitted into PVCu profiles, the special Schlegel PU foam formula provides a long lasting compression set recovery, also in an extremely cold climate. Q-Lon PU foam seals are manufactured to meet the challenging requirements of Rosstandart (conformity certificate POCC DE.СЛ16.HO1628) and other international standards. Schlegel use a quality management system registered and certified to norm ISO 9001:2008.



QL 4465

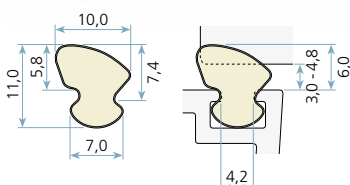

QL 9756

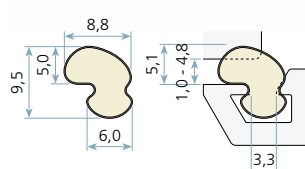



- Exceptional performance maintained over a wide temperature range
- Lower insertion forces speed up fitting by 15%
- Compensates for window movement
- Available colours: white, black and grey. Other colours available on request

Q-Lon Polyurethane Foam Seals: for aluminium window and door and window covering product applications

Specially designed to meet the different demands of aluminium windows and doors, Q-Lon polyurethane foam seals have excellent compression recovery of 99%, giving constant height at corners for improved weathering. With the rigid insert, Q-Lon seals eliminate any risk of shrink back that would compromise the weathering performance of the window or door.

The variety of flexible shapes and different colours makes these Q-Lon profiles particularly suited for sealing applications in window covering products such as roller shutters and screens. Fitted into aluminium head boxes, side guiding channels or bottom bars, Q-Lon polyurethane foam seals minimise light and air leaks, limit contamination and provide long lasting noise dampening effects.

Testing and results

Tested temperature range:	-60 °C to +70 °C
Heat conductivity:	0,041 W/mK at 0 °C
Compression force:	approx. < 15 N / 100 mm, < 10 N / 100 mm for lip seals
Compression set:	< 15% after 30 minutes relief of 50% compression at 70 °C and 24 hours (EN ISO 1856)
Weather resistance:	tested up to 20 years
Ozone resistance:	crack stage 0
Abrasion resistance:	no abrasion after in excess of 100,000 cycles with no failure mode
Colour fastness:	no contact discolouration (colour fastness index > 4)
Controls:	manufactured in accordance with ISO 9001



QL 4636

Windows / Other
T-Slot
Type A (5,3 mm)
Retention slot
throat: 3,2
Min. slot depth: 2,3
Seal gap: 1,0 - 2,5
Packaging: 300 m x 2

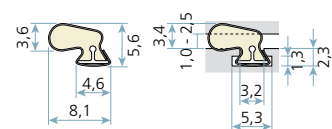

QL 4870

Windows / Doors /
Other
T-Slot
Type A (5,3 mm)
Retention slot
throat: 3,2
Min. slot depth: 2,3
Seal gap: 2,5 - 4,0
Packaging: 250 m x 2

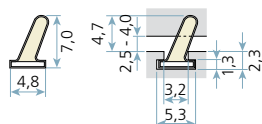

QL 6970

Windows / Doors /
Other
T-Slot
Type C (7,5 mm)
Retention slot
throat: 4,6
Min. slot depth: 2,3
Seal gap: 2,5 - 4,0
Packaging: 250 m x 2

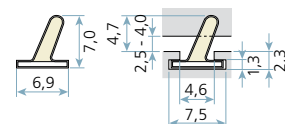

For aluminium applications

QL 48100

Windows / Doors / Other
T-Slot
Type A (5,3 mm)
Retention slot throat: 3,2
Min. slot depth: 2,3
Seal gap: 5,5 - 7,0
Packaging: 250 m x 2

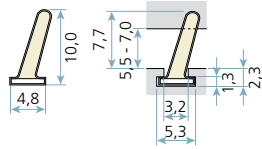

QL 48400

Windows / Other
T-Slot
Type A (5,3 mm)
Throat width: 3,2
Groove depth: 2,3
Seal gap: 0,5 - 1,5
Packaging: 200 m x 2 / 700 m x 2
900 m x 2

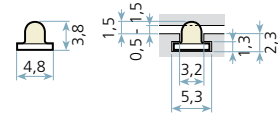

QL 48447

Windows / Doors / Other
T-Slot
Type A (5,3 mm)
Throat width: 3,2
Groove depth: 2,3
Seal gap: 2,5 - 7,0
Packaging: 250 m x 2

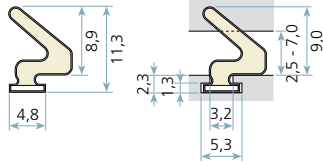

W33265

QL 48510

Windows / Other
T-Slot
Type A (5,3 mm)
Throat width: 3,2
Groove depth: 2,3
Seal gap: 1,1 - 2,4
Packaging: 200 m x 2 / 500 m x 2
900 m x 2

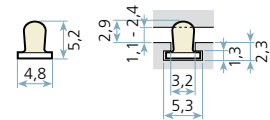

QL 48650

Windows / Other
T-Slot
Type A (5,3 mm)
Throat width: 3,2
Groove depth: 2,3
Seal gap: 1,8 - 3,4
Packaging: 200 m x 2 / 500 m x 2
700 m x 2

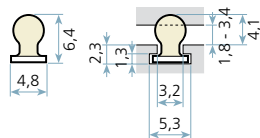

W25255

QL 48700

Windows / Doors / Other
T-Slot
Type A (5,3 mm)
Throat width: 3,2
Groove depth: 2,3
Seal gap: 2,5 - 6,0
Packaging: 250 m x 2

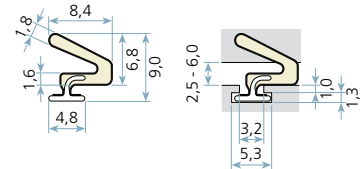

W33275

QL 48750

Windows / Other
T-Slot
Type A (5,3 mm)
Throat width: 3,2
Groove depth: 2,3
Seal gap: 2,7 - 4,6
Packaging: 200 m x 2 / 600 m x 2

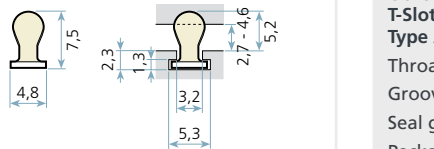

W25265

QL 48800

Windows / Doors / Other
T-Slot
Type A (5,3 mm)
Throat width: 3,2
Groove depth: 2,3
Seal gap: 2,5 - 7,0
Packaging: 250 m x 2

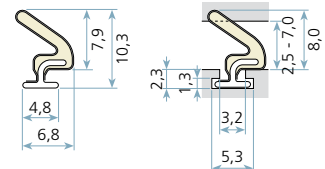

W34275

QL 48950

Windows / Doors / Other
T-Slot
Type A (5,3 mm)
Throat width: 3,2
Groove depth: 2,3
Seal gap: 4,0 - 6,5
Packaging: 200 m x 2 / 500 m x 2

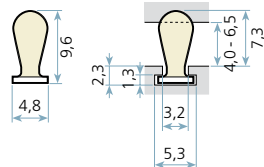

W34265

QL 57700

Windows / Other
T-Slot
Type B (6,3 mm)
Throat width: 3,8
Groove depth: 2,3
Seal gap: 2,3 - 4,0
Packaging: 200 m x 2 / 500 m x 2

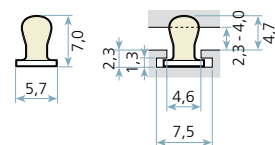

For aluminium applications

QL 69100

Windows / Doors / Other
T-Slot
Type C (7,5 mm)
Retention slot throat: 4,6
Min. slot depth: 2,3
Seal gap: 5,5 - 7,0
Packaging: 250 m x 2

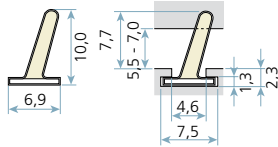

QL 69400

Windows / Other
T-Slot
Type C (7,5 mm)
Throat width: 4,6
Groove depth: 2,3
Seal gap: 0,5 - 1,5
Packaging: 200 m x 2 / 700 m x 2
900 m x 2

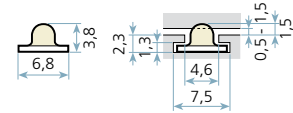

QL 69447

Windows / Doors / Other
T-Slot
Type C (7,5 mm)
Throat width: 4,6
Groove depth: 2,3
Seal gap: 2,5 - 7,0
Packaging: 250 m x 2

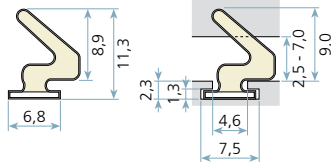

W33265

QL 69510

Windows / Other
T-Slot
Type C (7,5 mm)
Throat width: 4,6
Groove depth: 2,3
Seal gap: 1,1 - 2,4
Packaging: 700 m x 2

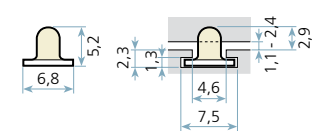

W15245

QL 69650

Windows / Other
T-Slot
Type C (7,5 mm)
Throat width: 4,6
Groove depth: 2,3
Seal gap: 1,8 - 3,4
Packaging: 200 m x 2 / 400 m x 2
600 m x 2

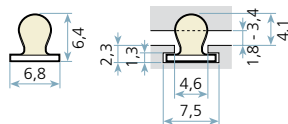

W25265

QL 69700

Windows / Doors / Other
T-Slot
Type C (7,5 mm)
Retention slot throat: 4,6
Min. slot depth: 2,3
Seal gap: 2,5 - 6,0
Packaging: 250 m x 2

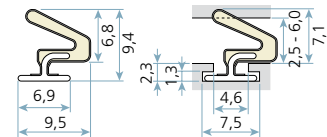

W33275

QL 69750

Windows / Other
T-Slot
Type C (7,5 mm)
Throat width: 4,6
Groove depth: 2,3
Seal gap: 2,7 - 4,6
Packaging: 200 m x 2 / 500 m x 2

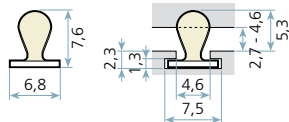

W24265

QL 69800

Windows / Doors / Other
T-Slot
Type C (7,5 mm)
Throat width: 4,6
Groove depth: 2,3
Seal gap: 2,5 - 7,0
Packaging: 250 m x 2

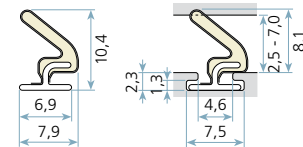

W34265

QL 69950

Windows / Doors / Other
T-Slot
Type C (7,5 mm)
Throat width: 4,6
Groove depth: 2,3
Seal gap: 4,0 - 6,5
Packaging: 200 m x 2 / 350 m x 2

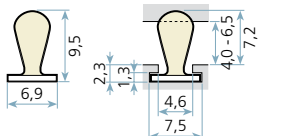

W34265

T-Slot dimensions

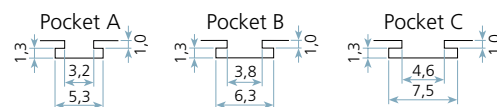



- Suitable for internal timber doors and sliding wardrobe, closet and sideboard doors
- Helps to reduce noise, dust and light contamination
- Available colours: white, black, bronze and grey. Other colours available on request

Q-Lon Polyurethane Foam Seals:

for interior design; internal door and furniture applications

Internal door and sliding door furniture seals are used as extra insulation to prevent air, dust, light and other contaminants from entering the gaps. The product is attached to the door frame creating a seal when the door is closed.

Testing and results

Compression set: < 15% after 1 hour relief of 50% compression at 70 °C and 24 hours. (DIN 53572)

Compression force: approx. 15 N at 25% compression per 100 mm, < 10 N for lip profiles

Tested temperature range: -60 °C to +70 °C

Heat conductivity: 0,041 W/mK at 0 °C

Long life performance: no change of the length-related and partial joint permeability

Paint compatibility: no adhesion, no hardening, no discolouration

Weather-resistant: tested up to 20 years



For interior design

QL 50

Internal doors /
Furniture

Groove width:
2,7 - 3,0

Min. groove
depth: 6,0

Rebate: 10,0

Seal gap: 3,0 - 5,0

Packaging: 250 m x 2

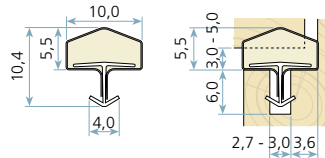

QL 55

Internal doors /
Furniture

Groove width:
2,7 - 3,0

Min. groove
depth: 6,0

Rebate: 10,0

Seal gap: 3,0 - 4,5

Packaging: 250 m x 2

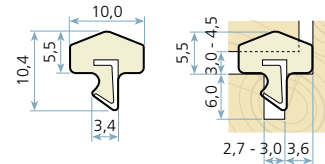

QL 60

Internal doors /
Furniture

Groove width:
2,7 - 3,0

Min. groove
depth: 6,0

Rebate: 10,0

Seal gap: 3,0 - 4,5

Packaging: 250 m x 2

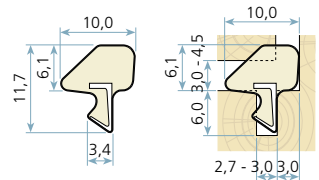

QL 836 (AQ 836)

Furniture

Groove width:
3,0 - 3,2

Min. groove
depth: 7,5

Seal gap: 5,0 - 7,5

Packaging: 125 m x 2

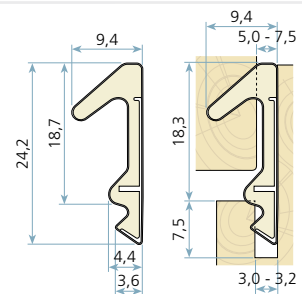

QL 3004 (AQ 99)

Furniture

Groove width:
2,7 - 3,0

Min. groove
depth: 6,0

Seal gap: 3,0 - 5,0

Packaging: 350 m x 2

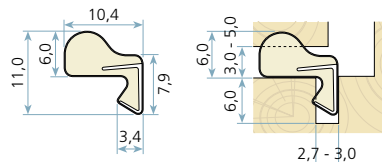

QL 3005 (AQ 63)

Furniture

Groove width:
2,7 - 3,0

Min. groove
depth: 6,0

Seal gap: 3,4 - 5,4

Packaging: 300 m x 2

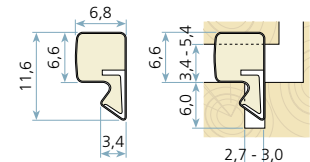

QL 3006 (AQ 89)

Furniture

Groove width:
2,7 - 3,0

Min. groove
depth: 6,0

Seal gap: 5,0 - 13,0

Packaging: 2,1 m x 150

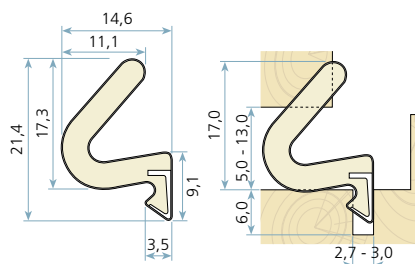

QL 3009 (AQ 21)

Furniture

Groove width:
2,7 - 3,0

Min. groove
depth: 6,0

Seal gap: 4,0 - 7,5

Packaging: 250 m x 2

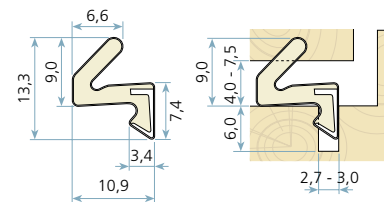

QL 3011 (AQ 109)

Furniture

Groove width:
2,7 - 3,0

Min. groove
depth: 6,0

Seal gap: 3,5 - 5,5

Packaging: 250 m x 2

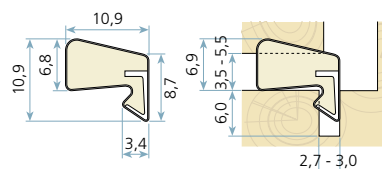

QL 3012 (AQ 33)

Furniture

Groove width:
2,7 - 3,0

Min. groove
depth: 6,0

Seal gap: 4,0 - 6,5

Packaging: 200 m x 2

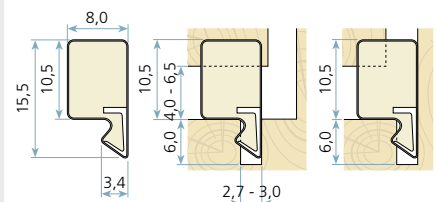

For interior design

QL 3013 (AQ 48)

Furniture

Groove width:
2,7 - 3,0

Min. groove
depth: 6,0

Seal gap: 2,0 - 3,0

Packaging: 500 m x 2

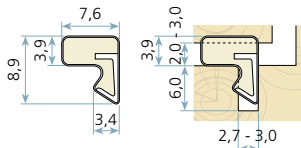

QL 3020 (AQ 124)

Entry doors

Groove width:
2,7 - 3,0

Min. groove
depth: 2,7

Rebate: 13,0

Seal gap: 3,5 - 7,5

Packaging: 125 m x 2

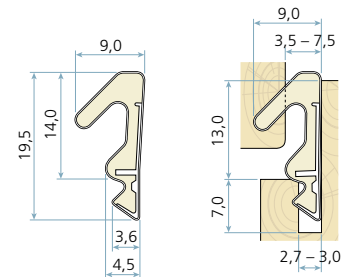

QL 3034

Furniture

Groove width:
2,7 - 3,0

Min. groove
depth: 8,0

Seal gap: 0,0 - 1,5

Packaging: 400 m x 2

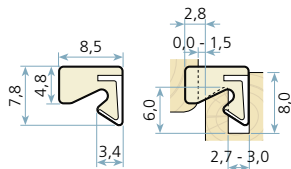

QL 3037 (AQ 4846)

Internal doors / Furniture

Groove width:
2,7 - 3,0

Min. groove
depth: 6,0

Rebate: 10,0

Seal gap: 3,5 - 5,6

Packaging: 200 m x 2

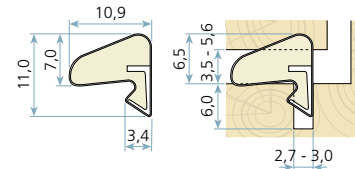

QL 3070

Furniture

Groove width:
2,7 - 3,0

Min. groove
depth: 8,0

Seal gap: 0,0 - 1,5

Packaging: 400 m x 2

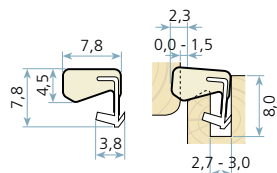

QL 3072

Internal doors / Furniture

Groove width:
2,7 - 3,2

Min. groove
depth: 6,5

Rebate: 10,0

Seal gap: 2,7 - 4,3

Packaging: 300 m x 2

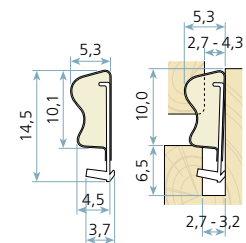

QL 3073

Furniture

Groove width:
4,0 - 5,0

Min. groove
depth: 7,5

Seal gap: 5,0 - 8,0

Packaging:
150 m x 2 / 200 m x 2

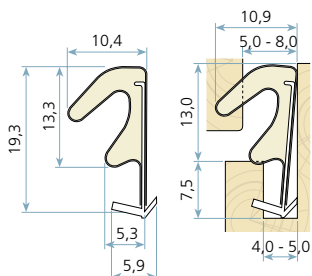

QL 3074

Furniture

Groove width:
2,7 - 3,2

Min. groove
depth: 6,5

Seal gap: 3,5 - 5,5

Packaging: 300 m x 2

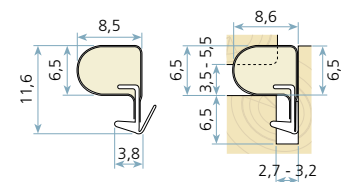

QL 3077

Furniture

Groove width:
2,7 - 3,0

Min. groove
depth: 6,0

Seal gap: 2,0 - 3,0

Packaging: 500 m x 2

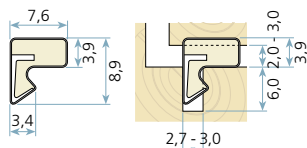

QL 3078

Furniture

Groove width:
3,0 - 3,3

Min. groove
depth: 6,0

Seal gap: 4,0 - 7,5

Packaging:
250 m x 2 / 300 m x 2

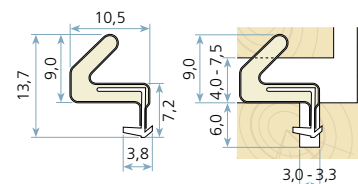

For interior design

QL 3079

Furniture

Groove width:
3,2 - 4,0

Min. groove
depth: 6,5

Seal gap: 2,7 - 4,3

Packaging: 300 m x 2

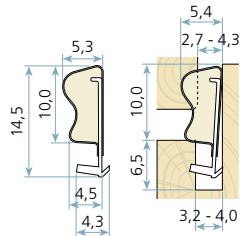

QL 3091

Internal doors / Furniture

Groove width:
4,0 - 5,0

Min. groove
depth: 7,5

Seal gap: 4,0 - 8,0

Packaging:
150 m x 2 / 400 m x 1

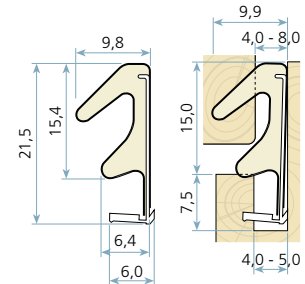

QL 3093

Furniture

Groove width:
2,7 - 3,0

Min. groove
depth: 7,0

Seal gap: 4,0 - 8,0

Packaging:
150 m x 2 / 400 m x 1

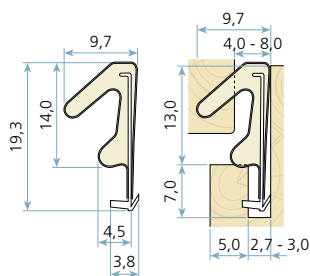

QL 3094

Internal doors / Furniture

Groove width:
2,7 - 3,2

Min. groove
depth: 6,5

Rebate: 10,0

Seal gap: 3,0 - 6,0

Packaging: 250 m x 2

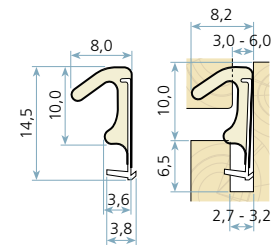

QL 3095

Furniture

Groove width:
3,5 - 4,0

Min. groove
depth: 6,5

Seal gap: 3,0 - 6,0

Packaging: 250 m x 2

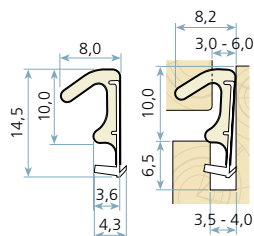

QL 3096

Furniture

Groove width:
4,0 - 5,0

Min. groove
depth: 7,5

Seal gap: 3,0 - 6,0

Packaging: 200 m x 2

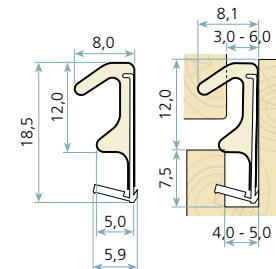

QL 3098

Furniture

Groove width:
3,0 - 4,0

Min. groove
depth: 7,5

Seal gap: 3,0 - 6,0

Packaging: 150 m x 2

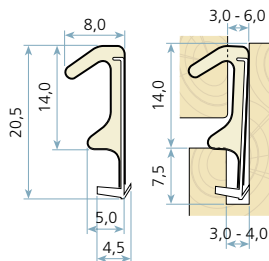

QL 3099

Furniture

Groove width:
3,0 - 3,3

Min. groove
depth: 6,0

Seal gap: 4,0 - 7,5

Packaging:
250 m x 2 / 300 m x 2

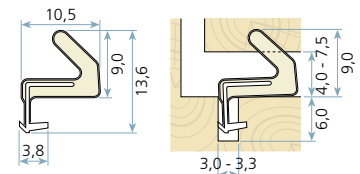

QL 3102

Furniture

Groove width:
3,7 - 4,2

Min. groove
depth: 7,0

Seal gap: 5,0 - 7,5

Packaging: 200 m x 2

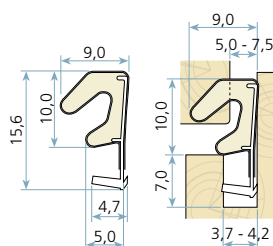

QL 3104

Furniture

Groove width:
4,0 - 5,0

Min. groove
depth: 7,5

Seal gap: 5,0 - 9,0

Packaging: 200 m x 2

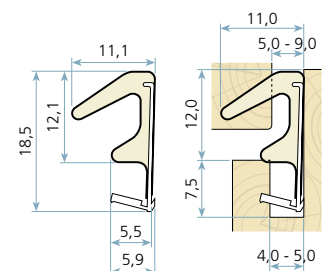

For interior design

QL 3106

Internal doors / Furniture

Groove width: 3,5 - 4,0
 Min. groove depth: 6,5
 Rebate: 12,0
 Seal gap: 3,0 - 5,0
 Packaging: 250 m x 2

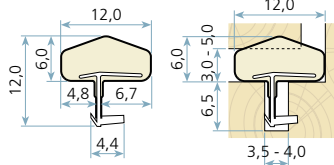

QL 3109

Furniture

Groove width: 4,0 - 5,0
 Min. groove depth: 7,0
 Seal gap: 5,0 - 9,0
 Packaging: 100 m x 2

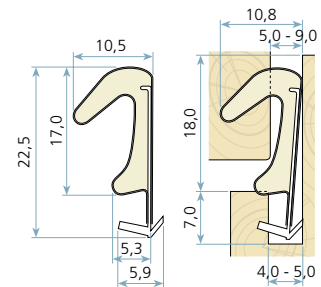

QL 3110

Internal doors / Furniture

Groove width: 3,5 - 4,0
 Min. groove depth: 6,5
 Rebate: 12,0
 Seal gap: 3,5 - 4,0
 Packaging: 150 m x 2

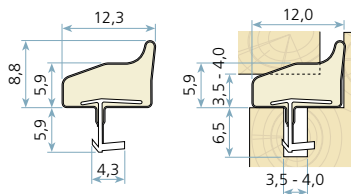

QL 3113

Internal doors / Furniture

Groove width: 3,5 - 4,0
 Min. groove depth: 7,0
 Rebate: 12,0
 Seal gap: 4,0 - 7,5
 Packaging: 200 m x 2

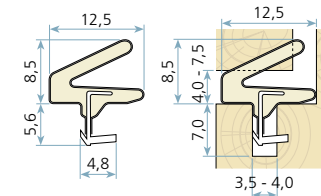

QL 3118

Furniture

Groove width: 3,0 - 3,3
 Min. groove depth: 7,0
 Seal gap: 3,0 - 7,5
 Packaging: 300 m x 2

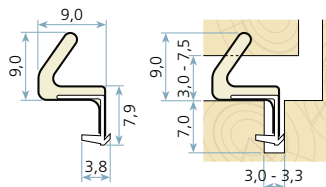

QL 3128

Furniture

Groove width: 2,7 - 3,0
 Min. groove depth: 7,0
 Seal gap: 4,0 - 7,5
 Packaging: 300 m x 2

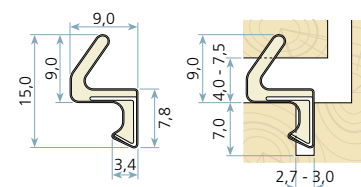

QL 3131

Furniture

Groove width: 2,7 - 3,0
 Min. groove depth: 8,0
 Seal gap: 0,0 - 1,5
 Packaging: 400 m x 2

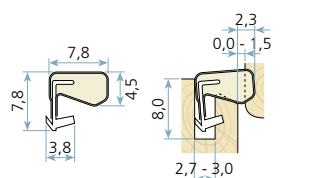

QL 3137

Internal doors / Furniture

Groove width: 2,7 - 3,2
 Min. groove depth: 6,0
 Rebate: 8,0
 Seal gap: 3,0 - 4,5
 Packaging: 250 m x 2

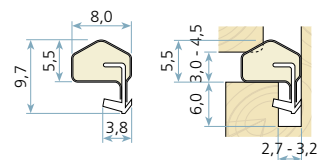

QL 3138

Internal doors / Furniture

Groove width: 2,7 - 3,2
 Min. groove depth: 6,0
 Rebate: 10,0
 Seal gap: 3,0 - 4,5
 Packaging: 250 m x 2

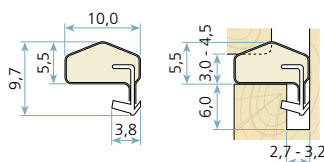

QL 3139

Furniture

Groove width: 3,0 - 3,3
 Min. groove depth: 7,0
 Seal gap: 3,0 - 7,5
 Packaging: 300 m x 2

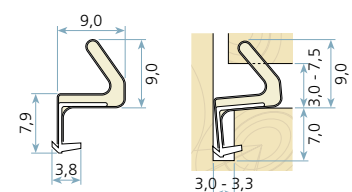

For interior design

QL 5626 (AQ 5626)

Furniture

Groove width:
2,7 - 3,0

Min. groove
depth: 6,0

Seal gap: 4,7 - 7,5

Packaging: 300 m x 2

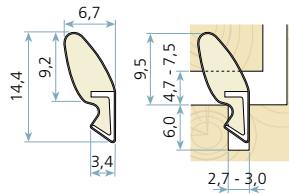

QL 5694 (AQ 5694)

Furniture

Groove width:
2,7 - 3,0

Min. groove
depth: 6,0

Seal gap: 6,0 - 11,0

Packaging:
200 m x 2 / 400 m x 1

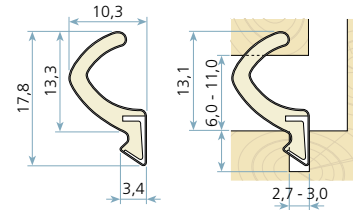

QL 7000

Furniture

Groove width:
2,7 - 3,0

Min. groove
depth: 6,0

Seal gap: 4,0 - 10,8

Packaging: 175 m x 2

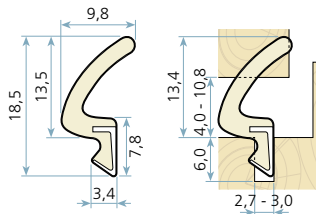

QL 7066 (AQ 7066)

Furniture

Groove width:
2,7 - 3,0

Min. groove
depth: 6,0

Seal gap: 4,8 - 7,7

Packaging:
400 m x 2 / 800 m x 2

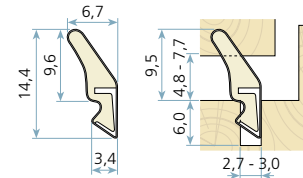

QL 9111 (AQ 9111)

Furniture

Groove width:
3,0 - 3,3

Min. groove
depth: 6,0

Seal gap: 4,8 - 7,9

Packaging: 300 m x 2

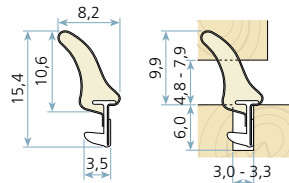

QL 9915

Internal doors / Furniture

Groove width:
2,7 - 3,0

Min. groove
depth: 6,0

Rebate: 11,0

Seal gap: 2,5 - 4,5

Packaging: 300 m x 2

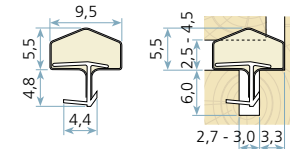

QL 9931

Internal doors / Furniture

Groove width:
3,0 - 3,5

Min. groove
depth: 6,5

Rebate: 12,0

Seal gap: 3,5 - 4,0

Packaging: 200 m x 2

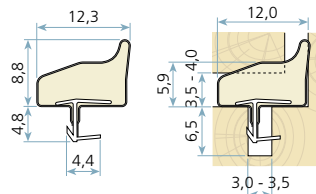

QL 9985

Internal doors / Furniture

Groove width:
2,7 - 3,0

Min. groove
depth: 6,0

Rebate: 10,0

Seal gap: 3,0 - 6,5

Packaging: 250 m x 2

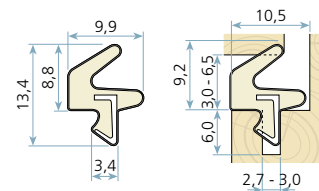

Case Study: Weco Windows, Spain

Weco Windows, winner of a.o. the Red Dot Design Award, A' Design Award and German Design Award, is a 'start-up' that focuses on innovation and design by putting wooden windows back in the panorama of contemporary technological design, using Q-Lon foam seals.

When they decided to launch an innovative window design, the architects Iciar de las Casas and Rosario Chao of Weco Windows did not hesitate to choose Schlegel Q-Lon foam seals for their technical values and maximum result in operation. With plywood frame and sheet of double or triple frameless glass, their window WECO 2C uses a system of triple weatherstripping to achieve: minimum thermal conductivity, and maximum soundproofing and energy efficiency. Another key factor in their nomination has been international recognition, to provide window performance proven in any part of the world. Including Q-Lon in its components, Weco Windows has revolutionised the classic wooden window, combining the warmth of this noble material with the contemporary look of the bare glass.

According to the Red Dot jury:

"WECO 2C impresses with its large-scale and elegant appearance made possible by the use of new technologies and high-quality construction elements."



The sash in this wood window incorporates glass and hardware in a single assembly, without a frame, maximizing the window's open area. The double or triple-glazed sash is mounted on the interior face of the wood frame in the wall. The windows are available in fixed, tilt-and-turn and sliding options, and lengths of up to six meters. The triple gasketing offers optimal thermal and acoustic performance. Contact Schlegel for advice on how to enhance your windows or doors.

QL 3097

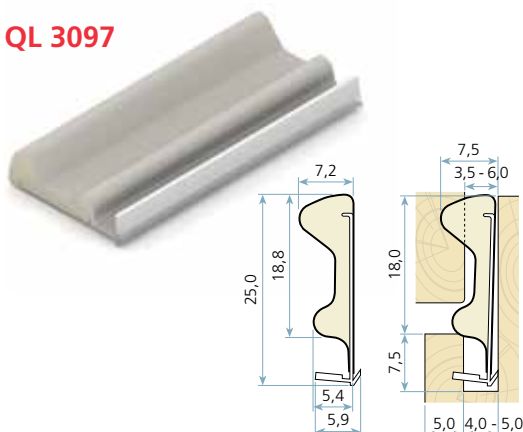

Accessories and Tools: for Q-Lon polyurethane foam seals

Q-Lon cover caps for French windows

Special colour co-ordinated caps made from resistant HDPE for various groove and rebate dimensions.

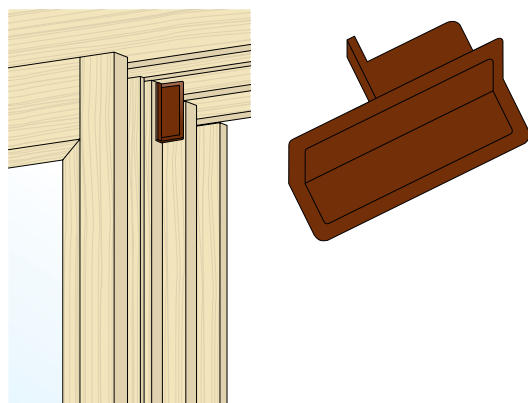

Q-Lon Seal	Part No.	Groove	Rebate
QL 3034	MIS-9093	3,0	–
QL 3053	MIS-9124	4,0	12,0
	MIS-9125	5,0	
	MIS-9184	4,0	18,0 – 20,0
	MIS-9185	5,0	
QL 3054	MIS-9103	3,0	10,0
QL 3070	MIS-9093	3,0	–
QL 3141	MIS-9123	3,0	10,0
	MIS-9183	3,0	20,0

Lozaron cover profiles for French windows

Colour coordinated profile made from TPE, compatible with acrylic paint.

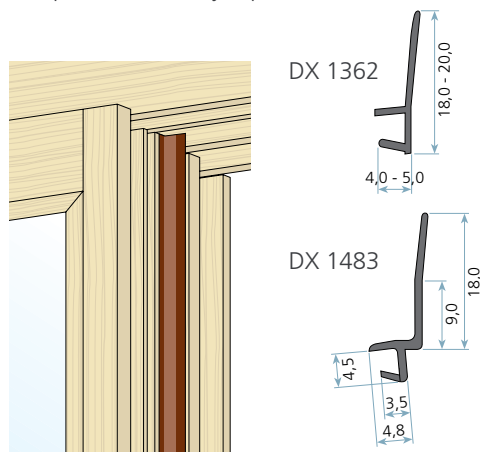

Q-Lon Seal	Part No.	Groove	Rebate
QL 3053	DX 1362	4,0 – 5,0	12 + 18 – 20
QL 3141	DX 1483	3,0	10,0 – 20,0



Q-Lon mitre cutters

Q-Lon mitre cutters have an insertion roll for 90° and end cut for assembly in the sash. Part no. MIS-9001-99.



Q-Lon insertion roller

Profile manual roller.
Part no. MIS-9007-01.



Q-Lon dispenser

Seal dispenser
for 1 coil.
Part no.
02800012.



Installation of Q-Lon in the sash (side joint)

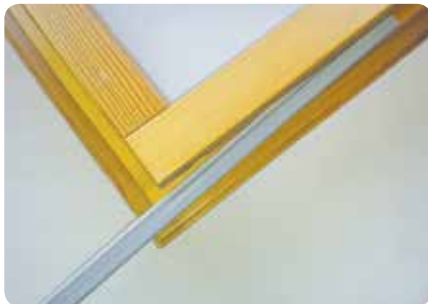

Step 1

The Q-Lon profile is pressed into the kerf at the centre of the sash.



Step 2

The Q-Lon pliers are placed in the rebate corner with the stop and a 90° mitre is cut out.

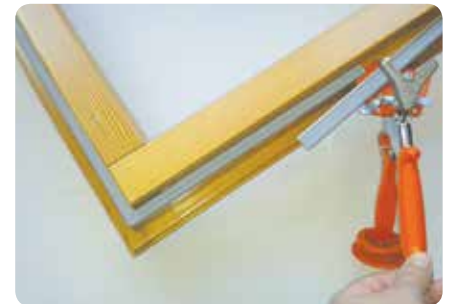

Step 3

The final cut: by positioning the pliers against the profile as shown, the final cut is made in the precise length.

Corner jointing with silicone mastic



Timber

Bonding of interrupted butt joint.



Timber

Bonding of mitre-cut joint.



PVCu and Aluminium

Enhancement of continuous seal.

Specification of silicone mastic: colourless WACKER Elastosil A07 RTV-1 silicone rubber / adhesive or equivalent.

Q-Lon Polyurethane Foam Seals: colour range

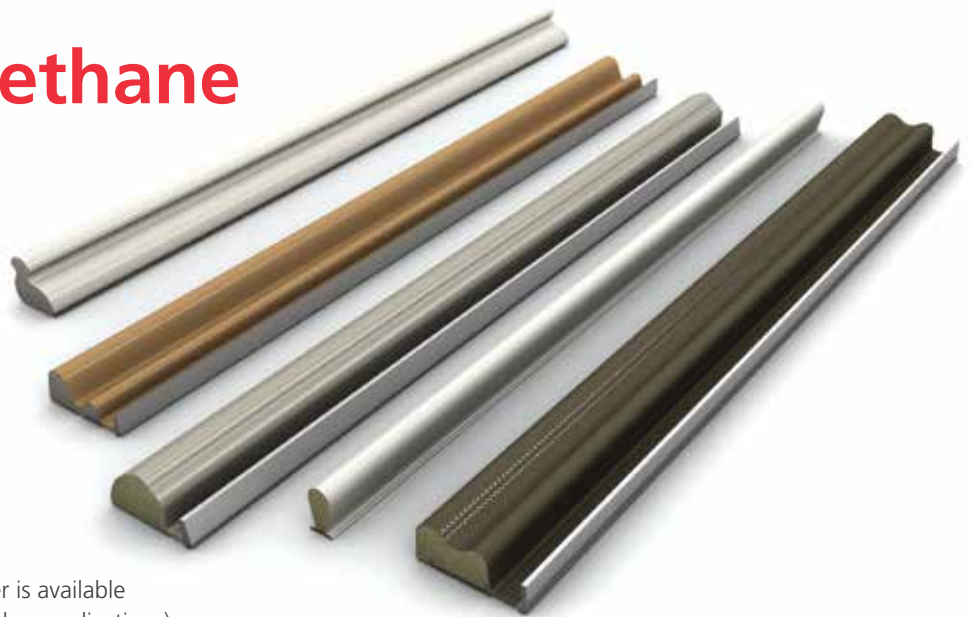

The unique Q-Lon seal is made from a special polyurethane foam, contained in a weather resistant polyethylene liner.

The standard foam colour is natural. The liner is available in the following main colours (bronze for timber applications):

White

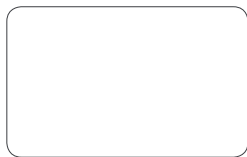

≈ RAL 9003

Silver Grey



≈ RAL 7001

Bronze

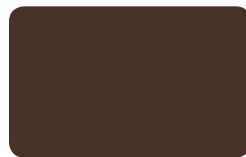

≈ RAL 8019

Black

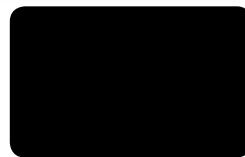

≈ RAL 9005

For further colour coordination, more options are available. Depending on the configuration, special conditions may apply. Upon request the foam can be produced in a different colour.

The liner can further be made available in the following colours:

Beige

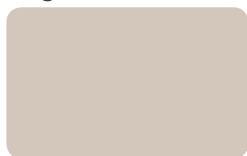

≈ RAL 1001

Light Oak



≈ RAL 8003

Ochre Brown



≈ RAL 8001

Fawn Brown



≈ RAL 8007

Chestnut Brown



≈ RAL 8015

Cream White

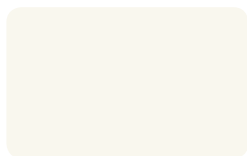

≈ RAL 9001

Light Grey

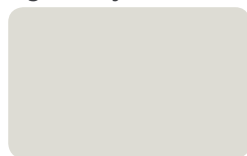

≈ RAL 7035

Dark Grey



≈ RAL 7032

Graphite Grey



≈ RAL 7024

Technical Information

Exterior Liner:	Polyethylene, low friction, UV stable
Melt Index Liner:	Approx. 0,85 g/10 min at 190 °C, 2,16 kg mass – 2,0MI
Thermal Conductivity Liner:	0,33 W/(m·K)
Thermal Conductivity Q-Lon Seal:	0,041 W/(m·K)
UV Resistance Liner:	8 GJ/m ² : black, white; 3 GJ/m ² : light oak; 2–3 GJ/m ² : bronze; 4 GJ/m ² : all other colours
Friction Coefficient Liner (Q-Lon Surface):	C-O-F of Quality 163,00; film against steel; DIN EN ISO 8295
	95 µm
	Static 0,241
	Kinetic 0,251

Which Seal has the Lowest Conductivity?

There is a proverb that says: A chain is only as strong as its weakest link. This also applies to the fenestration industry. Doors and windows only perform as well as the seal.

The thermal performance that can be achieved by a window or door is determined by many different factors. The composition of the frame material and the glass are both very important. A low quality seal, however, can easily spoil the energy saving effects of insulated profiles and argon filled HR glass.

Under EN ISO 10456:2007, the design thermal conductivity of different materials used for seals is detailed thus:

- EPDM 0,25 W/(m·K)
- PVCu 0,14 W/(m·K)
- PU 0,05 W/(m·K)

In accordance with EN12667 it now has been independently tested and certified by ift Rosenheim: Q-Lon has a measured low thermal conductivity of just 0,041 W/(m·K). This is better than any other weatherseal available in the market.

Compared to other seals, the loss of energy is reduced to the minimum. In combination with an excellent high compression recovery (on average higher than 90%) a high performance is also



guaranteed over the long term. Q-Lon foam seals come with a 10 year warranty and are a preferred choice among experts.

For a copy of the full report please contact your local Sales Manager or Customer Service Agent. A full overview of our wide selection of standard available Q-Lon seals for aluminium, PVCu and timber sections can be obtained via our website. Use the product filter function to select the best suitable Q-Lon seal for your application.

QL 3053
(timber)

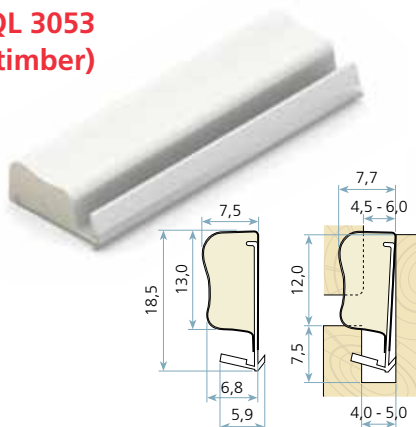

QL 69650
(PVCu / alu)

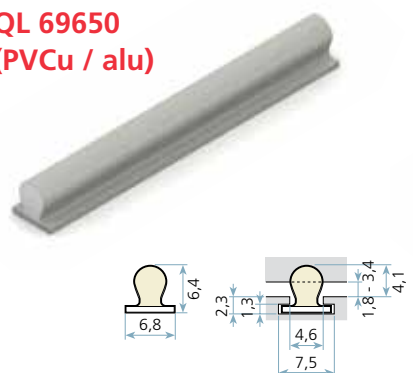

QL 9489
(PVCu)

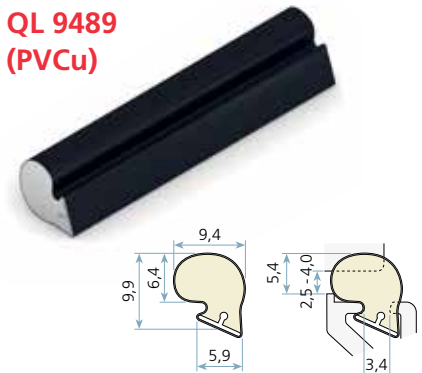



ENGINEERED COMPONENTS FOR THE FENESTRATION INDUSTRY



Schlegel Sealing Systems



Giese Hardware Systems

Schlegel International



Schlegel Ltd (A Company of Schlegel International)

Unit 25 Henlow Industrial Estate, Henlow Camp, Bedfordshire SG16 6DS – United Kingdom
Tel: +44 1462 815 500 | Fax: +44 1462 638 800 | email: info.henlow@schlegel.com

Care has been taken to ensure that the contents of this publication are accurate, but Schlegel and its subsidiary companies do not accept responsibility for errors or for information that is found to be misleading. Suggestions for, or description of, the end use or application of products or methods of working are for information only. All dimensions are in mm and are nominal. Schlegel reserve the right to change specification without prior notice.

Schlegel's names and logos and all related trademarks (including 'SCHLEGEL', 'SCHLEGEL Red Square Logo', 'Red Square Logo' and 'Q-Lon'), trade names, and other intellectual property are the property of Schlegel Acquisition Holdings Limited trading as Schlegel International and cannot be used without its express prior written permission. All rights reserved.

© Schlegel Acquisition Holdings Limited trading as Schlegel International 2017.



U0741101 – 03/2017

www.schlegel.com
www.giese.it