













Brand, special and product attributes

Denomination	Description	Attributes
Brand attributes	<ul style="list-style-type: none"> distinguish all HOPPE products convey the brand promise <ul style="list-style-type: none"> 10-year guarantee on the mechanical operation Made in Europe DIN EN ISO 14001 Environmentally-considerate manufacturing 	  
Special attributes	<ul style="list-style-type: none"> underline a unique selling proposition or an essential additional benefit of the HOPPE brand product 	<p>Quick-Fit® Quick fitting by simply putting the door handles together</p> <p>Secustik® Jamming mechanism to prevent the window hardware from being moved unlawfully from outside</p> <p>VarioFit® Adjustable spindle; bridges different profile thicknesses up to 10 mm</p> <p>Resista® 10-year surface guarantee</p>
Product attributes	<ul style="list-style-type: none"> present important information on a product or a benefit of the product are identified with the pictograms designed by HOPPE 	 Category of use grade 2 (3, 4) to DIN EN 1906  Very high corrosion resistance EN 1670, grade 4  Solid brass
Certification marks	<ul style="list-style-type: none"> identify the products that have been checked by a certification body are known trademarks apply internationally and regionally 	 For all window handles certified according to RAL (RAL-GZ 607/9) and all security door handle sets certified according to DIN 18257 and RAL-GZ 607/6

Explanation of Symbols

	OB (oval standard keyhole)
	PZ (profile cylinder)
	SK/OL (external: slotted head/ internal: turn button)
	Door thickness (in mm)
	Spindle size (in mm)
	Diameter (in mm)
duraplus®	HOPPE product line duraplus®: more than usual

Finishes

		
F41-R brushed chrome – Resista®	F42-R satin nickel – Resista®	F78-1-R light polished brass effect – Resista®
		
F84-1-R copper-coloured polished – Resista®	F96-1-R polished black – Resista®	F97-1-R satin anthracite – Resista®



Macau series – Distinctive shape in brass

The Macau brass series impresses with an elegant, classic wedge shape with an accentuating light edge on the front. The timeless shape can be combined with either round or square roses – the angular straight design can be emphasised using the rose shape or contrasted with a softer shape. In combination with a mini rose, the pure handle shape stands alone – and creates a unique effect on the door.

The interior door handle sets in the series are equipped with the **HOPPE Quick-Fit connection** – and can be fitted quickly, easily, and precisely. With **Secustik®**, window handles feature a locking mechanism to prevent unauthorised moving of the hardware from the outside, thus providing integrated basic security against break-ins. **VarioFit®** ensures patented stepless adjustment of the position of the spindle to the depth of the window profile.

With a selection of six attractive **contemporary colours**, the Macau series is also a perfect partner for different room effects. Dark handle finishes such as anthracite and black create effective accents in the room and can, for example, lend even more elegance to a tone-in-tone interior style. Copper and brass-coloured handles make a room look cosy and suit luxuriously designed rooms as well as Scandinavian-inspired living. The elegant matt chrome-plated or nickel-plated finishes reinterpret the classic colour scheme of door and window handles.

The Macau brass series features **Resista®** and thus comes with a 10-year surface guarantee. The high-quality appearance is long-lasting, even with intensive use or in harsh climatic conditions.



Quick-Fit

Macau - M1646/42K/42KS

duraplus®

- HOPPE brass handle set on rose with escutcheons for interior doors:
- Tested to **DIN EN 1906: 37-0140A**, handle set for commercial applications
 - Bearing: loose door handles, non-handed spring cassettes, maintenance-free slide bearing
 - Connection: **HOPPE Quick-Fit connection** with HOPPE solid spindle (receiver - receiver components)
 - Base: nylon
 - Fixing: concealed, multi-purpose screws



Description	Keyhole	F41-R Art. no.	F78-1-R Art. no.	F97-1-R Art. no.	P.U.	O.C.
Door handle set (receiver - receiver components)	40-50	8			1	10
	45-55	8	12001345	12001351	1	10

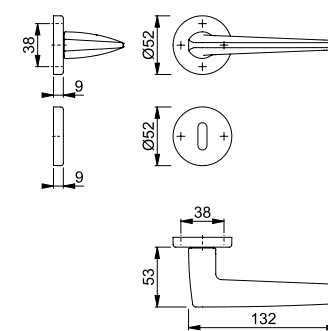

The Resista® guarantee applies to all finishes with the letter **R** in the finish key.

Resista®



Quick-Fit

Macau - M1646/843K/843KS

duraplus®

- HOPPE brass handle set on rose with escutcheons for interior doors:
- Tested to **DIN EN 1906: 37-0140A**, handle set for commercial applications
 - Bearing: loose door handles, non-handed spring cassettes, maintenance-free slide bearing
 - Connection: **HOPPE Quick-Fit connection** with HOPPE solid spindle (receiver - receiver components)
 - Base: nylon
 - Fixing: concealed, multi-purpose screws



Description	Keyhole	F41-R Art. no.	F78-1-R Art. no.	F84-1-R Art. no.	F96-1-R Art. no.	P.U.	O.C.	
								40-50
Door handle set (receiver - receiver components)	40-50	8	12011405	12012105	12012129	12001417	1	10
		8	12011253	12012312	12012361	12012294	1	10
Bathroom/WC handle set (receiver - receiver components)	37-47	8	12011277	12012397	12012415	12012385	1	10
Description	Keyhole	F97-1-R Art. no.	P.U.	O.C.				
					40-50	8	12012117	
Door handle set (receiver - receiver components)	40-50	8	12012117				1	10
		8	12012348				1	10
Bathroom/WC handle set (receiver - receiver components)	37-47	8	12012403				1	10

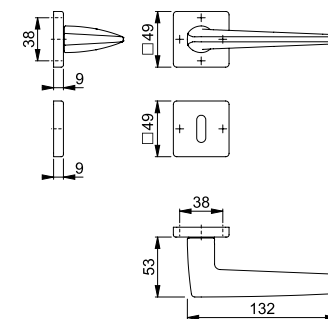

The Resista® guarantee applies to all finishes with the letter **R** in the finish key.

Resista®



Quick-Fit

Macau - M1646/845

duraplus®

- HOPPE brass handle set on mini rose without escutcheons for interior doors:
- Bearing: loose door handles, maintenance-free slide bearing
 - Connection: **HOPPE Quick-Fit connection** with HOPPE solid spindle (receiver - receiver components)
 - Fixing: plug-in mini roses
 - Special feature: non-screw fitting



Description	Keyhole	F42-R Art. no.	F78-1-R Art. no.	F84-1-R Art. no.	F96-1-R Art. no.	P.U.	O.C.	
								40-54
Door handle set without escutcheon	40-54	8	12001466	12012063	12012087	12001478	1	10
Description	Keyhole	F97-1-R Art. no.	P.U.	O.C.				
					40-54	8	12012075	
Door handle set (receiver - receiver components)	40-54	8	12012075				1	10

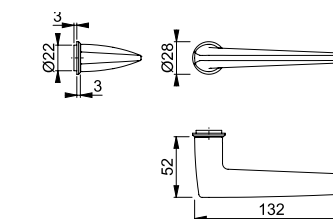

The Resista® guarantee applies to all finishes with the letter **R** in the finish key.

Resista®



Secustik®
VarioFit®

Macau - M0646/US943

duraplus®

- HOPPE brass turn/tilt window handle with **Secustik®** and **VarioFit®**:
- Stop-in position: 45°
 - Cover: partial cover cap
 - Base: nylon with brass frame, supporting lugs
 - Spindle: HOPPE solid spindle, adjustable length of 10 mm, smooth adjustment thanks to the pressure spring integrated in the handle neck
 - Fixing: concealed, M5 thread screws
 - Special feature: built-in basic security



Description	Lugs Ø	Projecting Screws	F41-R Art. no.	F78-1-R Art. no.	F84-1-R Art. no.	F96-1-R Art. no.	P.U.	O.C.	
									10
Window handle, piece	10	7	32-42 M5 x 45/50	12013213	12013274	12013328	12013262	1	10
Description	Lugs Ø	Projecting Screws	F97-1-R Art. no.	P.U.	O.C.				
						10	7	32-42 M5 x 45/50	12013316
Window handle, piece	10	7	32-42 M5 x 45/50	12013316				1	10

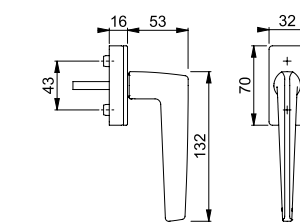

The Resista® guarantee applies to all finishes with the letter **R** in the finish key.

Resista®