











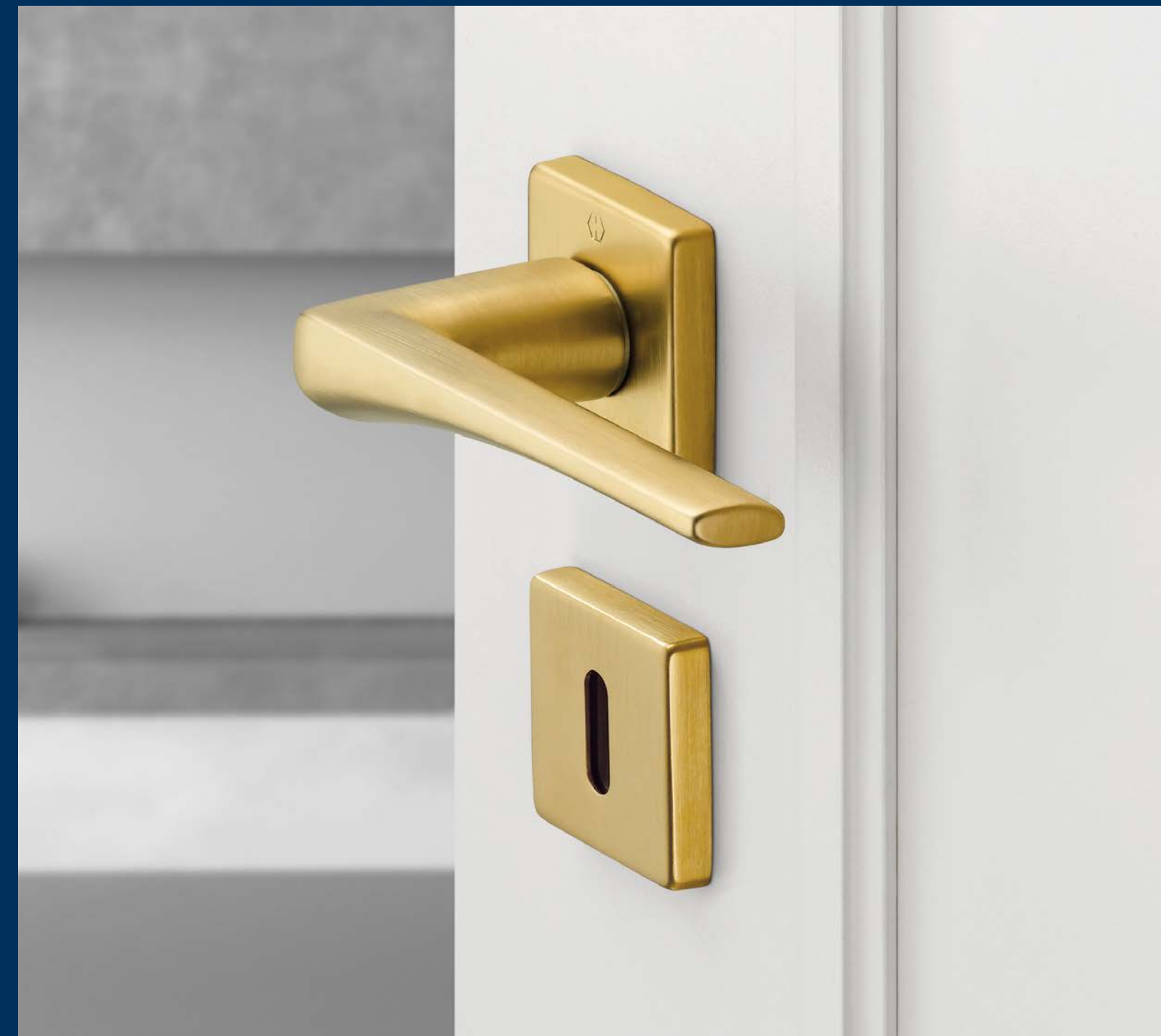

**Brand, special and product attributes**

Denomination	Description	Attributes
<b>Brand attributes</b>	<ul style="list-style-type: none"> <li>distinguish all HOPPE products</li> <li>convey the brand promise                             <ul style="list-style-type: none"> <li>10-year guarantee on the mechanical operation</li> <li>Made in Europe</li> <li>DIN EN ISO 14001 Environmentally-considerate manufacturing</li> </ul> </li> </ul>	  
<b>Special attributes</b>	<ul style="list-style-type: none"> <li>underline a unique selling proposition or an essential additional benefit of the HOPPE brand product</li> </ul>	<p><b>Quick-Fit®</b> Quick fitting by simply putting the door handles together</p> <p><b>Secustik®</b> Jamming mechanism to prevent the window hardware from being moved unlawfully from outside</p> <p><b>VarioFit®</b> Adjustable spindle; bridges different profile thicknesses up to 10 mm</p> <p><b>Resista®</b> 10-year surface guarantee</p>
<b>Product attributes</b>	<ul style="list-style-type: none"> <li>present important information on a product or a benefit of the product</li> <li>are identified with the pictograms designed by HOPPE</li> </ul>	 Category of use grade 2 (3, 4) to DIN EN 1906  Very high corrosion resistance EN 1670, grade 4  Solid brass
<b>Certification marks</b>	<ul style="list-style-type: none"> <li>identify the products that have been checked by a certification body</li> <li>are known trademarks</li> <li>apply internationally and regionally</li> </ul>	 For all window handles certified according to RAL (RAL-GZ 607/9) and all security door handle sets certified according to DIN 18257 and RAL-GZ 607/6



**Explanation of Symbols**

	OB (oval standard keyhole)
	PZ (profile cylinder)
	SK/OL (external: slotted head/ internal: turn button)
	Door thickness (in mm)
	Spindle size (in mm)
	Diameter (in mm)
<b>duraplus®</b>	HOPPE product line duraplus®: more than usual

**Finishes**



## Canberra series – Curved shape in brass

The Canberra brass series combines a straight edge on the top of the handle with a dynamically curved line underneath to create an attractive and harmonious overall impression. By combining it with either round or square roses, the angular or curved parts of the handle design can be visually enhanced in the interior door handle sets in this series.

The interior door handle sets in the series are equipped with the **HOPPE Quick-Fit connection** – and can be fitted quickly, easily, and precisely. With **Secustik®**, window handles feature a locking mechanism to prevent unauthorised moving of the hardware from the outside, thus providing integrated basic security against break-ins. **VarioFit®** ensures patented stepless adjustment of the position of the spindle to the depth of the window profile. Due to their curved shape, the window handles are only available in the right-hand version.

With a selection of five attractive **contemporary colours**, the Canberra brass series is also a perfect partner for different room effects. Dark handle finishes such as anthracite and black create effective accents in the room and can, for example, lend even more elegance to a tone-in-tone interior style. Copper and brass-coloured handles make a room look cosy and suit luxuriously designed rooms as well as Scandinavian-inspired living. The elegant matt chrome-plated finishes reinterpret the classic colour scheme of door and window handles.

The Canberra brass series features **Resista®** and thus comes with a 10-year surface guarantee. The high-quality appearance is long-lasting, even with intensive use or in harsh climatic conditions.



Quick-Fit

### Canberra - M1638/843K/843KS

duraplus®

HOPPE brass handle set on rose with escutcheons for interior doors:

- Tested to **DIN EN 1906: 37-0140A**, handle set for commercial applications
- Bearing: loose door handles, non-handed spring cassettes, maintenance-free slide bearing
- Connection: **HOPPE Quick-Fit connection** with HOPPE solid spindle (receiver - receiver components)
- Base: nylon
- Fixing: concealed, multi-purpose screws



Description	Keyhole	F41-R Art. no.	F78-1-R Art. no.	F84-1-R Art. no.	F96-1-R Art. no.	P.U.	O.C.	
								8
Door handle set (receiver - receiver components)	8	<b>12002756</b>	12016846	12016865	12002768	1	10	
	8	12016871	12016895	12016913	12016883	1	10	
Bathroom/WC handle set (receiver - receiver components)	8 5-8	12016925	12016949	12016962	12016937	1	10	
Description	Keyhole	F97-1-R Art. no.					P.U.	O.C.
Door handle set (receiver - receiver components)	8	12016858					1	10
	8	12016901					1	10
Bathroom/WC handle set (receiver - receiver components)	8 5-8	12016950					1	10

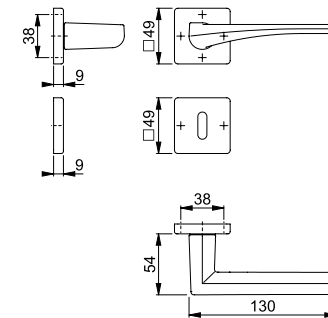

The Resista® guarantee applies to all finishes with the letter **R** in the finish key.

Resista®



Quick-Fit

### Canberra - M1638/42K/42KS

duraplus®

HOPPE brass handle set on rose with escutcheons for interior doors:

- Tested to **DIN EN 1906: 37-0140A**, handle set for commercial applications
- Bearing: loose door handles, non-handed spring cassettes, maintenance-free slide bearing
- Connection: **HOPPE Quick-Fit connection** with HOPPE solid spindle (receiver - receiver components)
- Base: nylon
- Fixing: concealed, multi-purpose screws



Description	Keyhole	F41-R Art. no.	F96-1-R Art. no.	P.U.	O.C.
Door handle set (receiver - receiver components)	8	<b>12002975</b>	12002987	1	10
	8	12011545		1	10

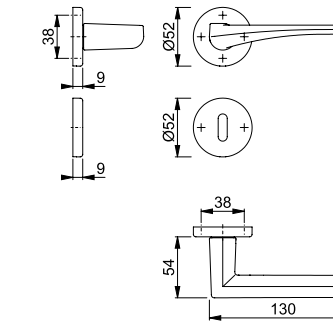

The Resista® guarantee applies to all finishes with the letter **R** in the finish key.

Resista®



Secustik®  
VarioFit®

### Canberra - M0638/US943

duraplus®

HOPPE brass turn/tilt window handle with **Secustik®** and **VarioFit®**:

- Stop-in position: 45°
- Cover: partial cover cap
- Base: nylon with brass frame, supporting lugs
- Spindle: HOPPE solid spindle, adjustable length of 10 mm, smooth adjustment thanks to the pressure spring integrated in the handle neck
- Fixing: concealed, M5 thread screws
- Special feature: built-in basic security



Description	Lugs Ø	Projecting Screws	F41-R Art. no.	F78-1-R Art. no.	F84-1-R Art. no.	F96-1-R Art. no.	P.U.	O.C.	
									10
Window handle, piece	10	32-42 M5 x 45/50	<b>12014308</b>	12014321	12014345	12014315	1	10	
Description	Lugs Ø	Projecting Screws	F97-1-R Art. no.					P.U.	O.C.
Window handle, piece	10	32-42 M5 x 45/50	12014333					1	10

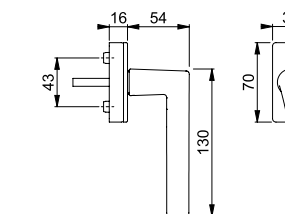

The Resista® guarantee applies to all finishes with the letter **R** in the finish key.

Resista®