

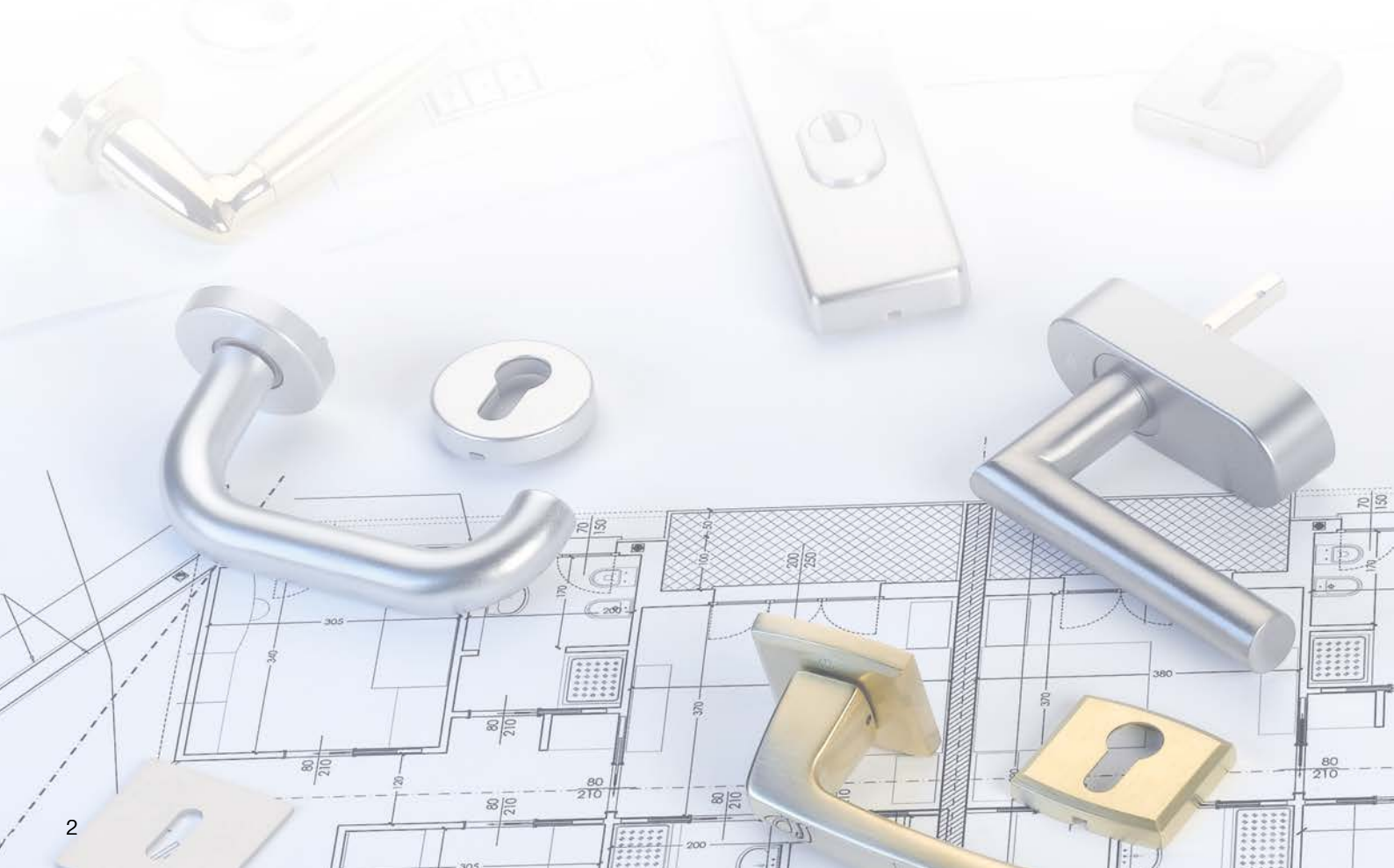

Elegant and Pure:  
HOPPE Mini Roses

# For all HOPPE Door and Window Handles ...



## HOPPE – Series with Mini Roses



**Amsterdam**  
(E)1400  
page 5



**Dallas**  
(E/M)1643  
page 7



**Hamburg**  
1700  
page 11



**Houston**  
M1623  
page 13



**Los Angeles**  
M1642  
page 15



**Macau**  
M1646  
page 17



**Stockholm**  
(E)1140  
page 19



**Door Preparation and Assembly**  
page 21



**Explanation of Attributes and Symbols**  
page 24

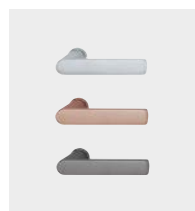

**HOPPE**  
**Finish Chart**  
page 25

## ARRONE – Magnetic Locks



**AR3313**  
page 22

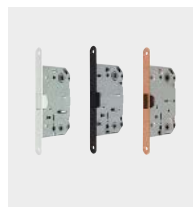

**ARRONE**  
**Finish Chart**  
page 25

### Purism in the Details: HOPPE Mini Roses

Mini roses show door handles in a completely new light. They are hardly noticeable on the door. As a result, the handle itself becomes more prominent, creating a fascinating interplay between the handle and the door.

Interior door sets with mini roses are available in aluminium, stainless steel and brass. A standard door set consists of a pair of door handles and the matching handle roses. Escutcheons, which are also available in a special version for bathroom doors, can be added if required.

All sets are fitted with the patented **HOPPE Quick-Fit connection**, which enables the door handles to be assembled quickly and easily without any tools and ensures a firm fit. The key point of the proven technology is the blocking mechanism, developed by HOPPE, in the door handle receiver component. It holds the solid spindle of the other handle firmly and without play. Simply attach the mini roses and plug in the door handles – all done!

Naturally, HOPPE's interior door sets with mini roses also come with a 10-year operational guarantee.

Choose the right handle shape for you from our modern range and enjoy the pure design of door and handle.









Quick-Fit

## Amsterdam - 1400/845

duraplus

HOPPE aluminium handle set on mini rose without escutcheons for interior doors:

- Bearing: loose door handles, maintenance-free slide bearing
- Connection: **HOPPE Quick-Fit connection** with HOPPE solid spindle (receiver - receiver components)
- Fixing: plug-in mini roses
- Special feature: non-screw fitting

Description				F9016M	F9714M			P.U.	O.C.
				Art. no.	Art. no.				
Door handle set without escutcheon	35-45	8		<b>11695766</b>	11659130			1	10

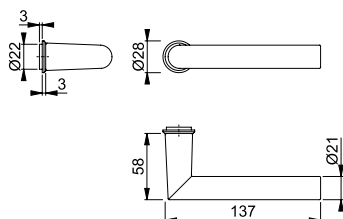

Quick-Fit

## Amsterdam - E1400Z/845

duraplus

HOPPE stainless steel handle set on mini rose without escutcheons for interior doors:

- Bearing: loose door handles, maintenance-free slide bearing
- Connection: **HOPPE Quick-Fit connection** with HOPPE solid spindle (receiver - receiver components)
- Fixing: plug-in mini roses
- Special feature: non-screw fitting



Description				F69	F78-1-R	F84-1-R		P.U.	O.C.
				Art. no.	Art. no.	Art. no.			
Door handle set without escutcheon	36-54	8		10781648				1	10
			8/8,5		<b>11658757</b>	11658794		1	10

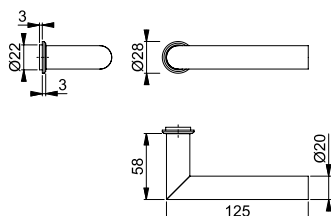

The Resista® guarantee applies to all finishes with the letter **R** in the finish key.

Resista







Quick-Fit

## Dallas - 1643/845

duraplus

HOPPE aluminium handle set on mini rose without escutcheons for interior doors:

- Bearing: loose door handles, maintenance-free slide bearing
- Connection: **HOPPE Quick-Fit connection** with HOPPE solid spindle (receiver - receiver components)
- Fixing: plug-in mini roses
- Special feature: non-screw fitting

Description			F9016M	F9714M			P.U.	O.C.
			Art. no.	Art. no.				
Door handle set without escutcheon	35-55	8	<b>11633591</b>	11621849			1	10

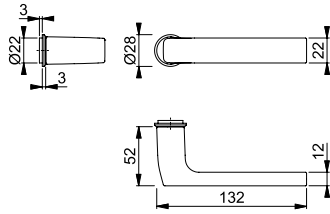

Quick-Fit



## Dallas - E1643Z/845

duraplus

HOPPE stainless steel handle set on mini rose without escutcheons for interior doors:

- Bearing: loose door handles, maintenance-free slide bearing
- Connection: **HOPPE Quick-Fit connection** with HOPPE solid spindle (receiver - receiver components)
- Fixing: plug-in mini roses
- Special feature: non-screw fitting



Description			F69				P.U.	O.C.
			Art. no.					
Door handle set without escutcheon	36-54	8	<b>10781656</b>				1	10

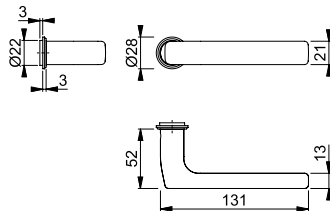





Quick-Fit<sup>1</sup>





**Dallas - M1643/845**

duraplus

HOPPE brass handle set on mini rose without escutcheons for interior doors:

- Bearing: loose door handles, maintenance-free slide bearing
- Connection: **HOPPE Quick-Fit connection** with HOPPE solid spindle (receiver - receiver components)
- Fixing: plug-in mini roses
- Special feature: non-screw fitting



Description			F49-R	F78-1-R	F84-1-R	F96-1-R	P.U.	O.C.
			Art. no.	Art. no.	Art. no.	Art. no.		
Door handle set without escutcheon	30-44	8	11651994				1	10
	35-55			11717185	<b>11717221</b>	11717208	1	10
Description			F97-1-R				P.U.	O.C.
Door handle set without escutcheon	35-55	8	11717142				1	10

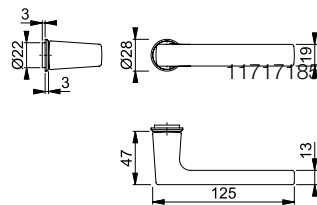

The Resista<sup>®</sup> guarantee applies to all finishes with the letter **R** in the finish key.

**Resista**









Quick-Fit

## Hamburg - 1700/845

duraplus

HOPPE aluminium handle set on mini rose without escutcheons for interior doors:

- Bearing: loose door handles, maintenance-free slide bearing
- Connection: **HOPPE Quick-Fit connection** with HOPPE solid spindle (receiver - receiver components)
- Fixing: plug-in mini roses
- Special feature: non-screw fitting

Description				F9016M	F9714M			P.U.	O.C.
				Art. no.	Art. no.				
Door handle set without escutcheon	35-45	8		11879270	<b>11879257</b>			1	10

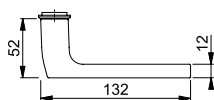
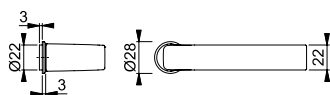





Quick-Fit



## ■ Houston - M1623/845

duraplus

HOPPE brass handle set on mini rose without escutcheons for interior doors:

- Bearing: loose door handles, maintenance-free slide bearing
- Connection: **HOPPE Quick-Fit connection** with HOPPE solid spindle (receiver - receiver components)
- Fixing: plug-in mini roses
- Special feature: non-screw fitting



Description				F41-R	F78-1-R	F96-1-R	F97-1-R	P.U.	O.C.
				Art. no.	Art. no.	Art. no.	Art. no.		
Door handle set without escutcheon	40-54	8		<b>10782667</b>	11948590	11948607	11948619	1	10

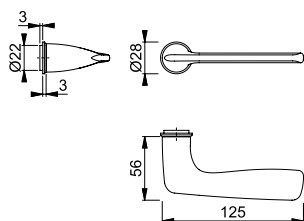

The Resista® guarantee applies to all finishes with the letter **R** in the finish key.

Resista







Quick-Fit

## Los Angeles - M1642/845

duraplus

HOPPE brass handle set on mini rose without escutcheons for interior doors:

- Bearing: loose door handles, maintenance-free slide bearing
- Connection: **HOPPE Quick-Fit connection** with HOPPE solid spindle (receiver - receiver components)
- Fixing: plug-in mini roses
- Special feature: non-screw fitting



Description			F41-R	F49-R	F78-1-R	F84-1-R	P.U.	O.C.
			Art. no.	Art. no.	Art. no.	Art. no.		
Door handle set without escutcheon	40-54	8	10782675	10782747			1	10
	35-55	8/8,5			11722423	11722526	1	10
Description			F96-1-R	F97-1-R	F9714M		P.U.	O.C.
			Art. no.	Art. no.	Art. no.			
Door handle set without escutcheon	40-54	8	11722447	<b>11722405</b>	11903016		1	10

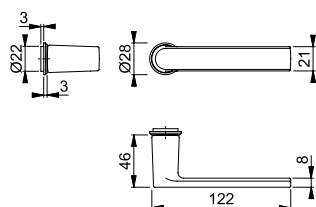

The Resista® guarantee applies to all finishes with the letter **R** in the finish key.

Resista





Quick-Fit





## Macau - M1646/845

duraplus

HOPPE brass handle set on mini rose without escutcheons for interior doors:

- Bearing: loose door handles, maintenance-free slide bearing
- Connection: **HOPPE Quick-Fit connection** with HOPPE solid spindle (receiver - receiver components)
- Fixing: plug-in mini roses
- Special feature: non-screw fitting



Description				F41-R	F42-R	F78-1-R	F84-1-R	P.U.	O.C.
				Art. no.	Art. no.	Art. no.	Art. no.		
Door handle set without escutcheon	40-54	8		12200724	12001466	12012063	12012087	1	10
Description				F96-1-R	F97-1-R			P.U.	O.C.
Door handle set without escutcheon	40-54	8		12001478	<b>12012075</b>			1	10

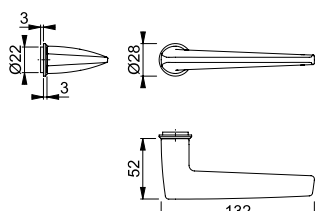

The Resista® guarantee applies to all finishes with the letter **R** in the finish key.

Resista







Quick-Fit

## Stockholm - 1140/845

duraplus

HOPPE aluminium handle set on mini rose without escutcheons for interior doors:

- Bearing: loose door handles, maintenance-free slide bearing
- Connection: **HOPPE Quick-Fit connection** with HOPPE solid spindle (receiver - receiver components)
- Fixing: plug-in mini roses
- Special feature: non-screw fitting

Description				F9016M	F9714M			P.U.	O.C.
				Art. no.	Art. no.				
Door handle set without escutcheon	35-55	8		<b>11634054</b>	11650005			1	10

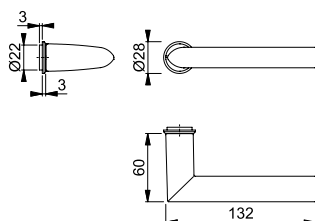

Quick-Fit



## Stockholm - E1140Z/845

duraplus

HOPPE stainless steel handle set on mini rose without escutcheons for interior doors:

- Bearing: loose door handles, maintenance-free slide bearing
- Connection: **HOPPE Quick-Fit connection** with HOPPE solid spindle (receiver - receiver components)
- Fixing: plug-in mini roses
- Special feature: non-screw fitting



Description				F69				P.U.	O.C.
				Art. no.					
Door handle set without escutcheon	36-54	8		<b>10781630</b>				1	10

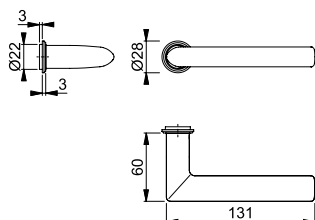



## Door Preparation

Accurate door preparation is required since the size of the roses has been reduced to a minimum.

The hole for the handle must be 22 mm in diameter. A special drill or CNC machine is recommended for optimum results.

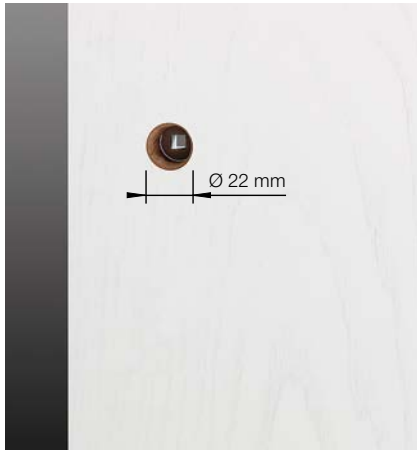

Door preparation for HOPPE handle sets on mini rose without escutcheons.

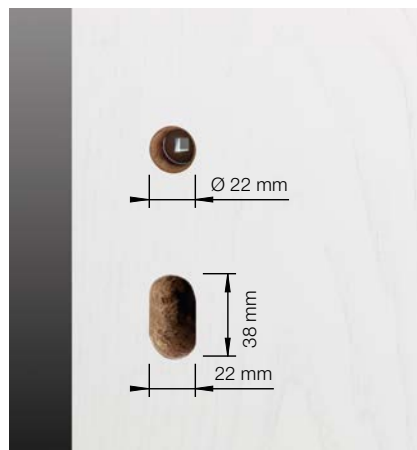

Door preparation for HOPPE handle sets on mini rose with escutcheons.

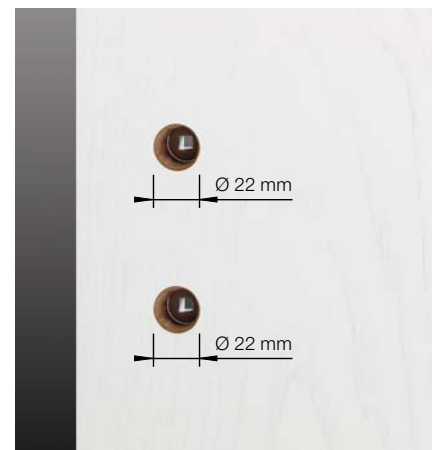

Door preparation for HOPPE handle sets on mini rose with emergency release and turn for bathroom/WC doors.

## Assembly

The handle roses are fastened to the door by putting the door handles together thanks to the **HOPPE Quick-Fit connection**.

The M846S escutcheons just need to be plugged together. To attach the MSK91/845S/OL45 bathroom/WC roses, plug the emergency release and turn together and fasten using a grub screw. In both cases, silicone helps to keep the escutcheons fixed to the door.

Ask your HOPPE dealer for more information on M846S escutcheons and bathroom/WC roses. Selection to match the handles is available.

# ARRONE

## ARRONE – Developing and Enhancing the Product Range

Under the ARRONE brand name, HOPPE Group offers a comprehensive range of architectural quality door and window hardware along with accessories. Many products are manufactured exclusively by leading hardware manufacturers throughout the world. Within this extensive range are door closing devices, panic and emergency exit devices, hinges, rim and mortice locks, door and pull handles, access control, signage and accessories. ARRONE products are designed and manufactured to complement the HOPPE range of aluminium, brass, stainless steel and nylon door and window hardware.

### Magnetic locks

Magnetic locks are used where a protruding latch and a visible strike plate would be obtrusive. They ensure low-noise and smooth use of interior door handle sets. Above all, they impress with their flush design. When the door is open, the latch remains completely concealed in the lock case. When the door is closed, the latch springs into the strike plate of the door frame. By pushing down the handle, the latch is retracted from the striking plate and the door can be opened.

ARRONE magnetic locks perfectly complement HOPPE handles – especially those with minimalistic mini roses. A range of contemporary colours matches the handles sets, including matt black, matt white and copper finishes.





## AR3313

ARRONE magnetic bathroom lock:

- Function: Deadbolt operation
- Backset: 50 mm
- Centre's: 96 mm
- Deadbolt: Plastic coated magnetic
- Forend/strike material: Steel
- Forend type: Single
- Forend shape: Radius
- Certification/Testing: Not applicable
- Finishes: Brushed nickel, white, black, copper, titanium



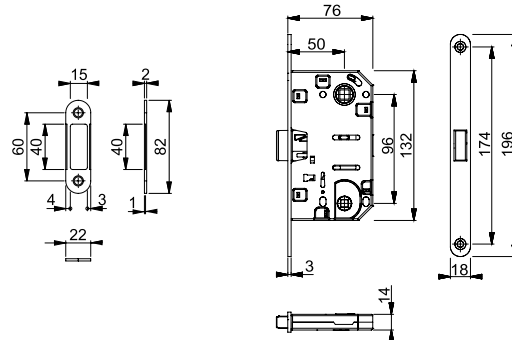



Product ref.	Article description	Finish	Article no.
<b>AR3313-50/96-MNP</b>	Magnetic mortise bathroom lock	<b>MNP</b>	<b>50015576</b>
<b>AR3313-50/96-MNP</b>	Magnetic mortise bathroom lock	WHT	50015588
<b>AR3313-50/96-MNP</b>	Magnetic mortise bathroom lock	BLK	50015595
<b>AR3313-50/96-PVD-COP</b>	Magnetic mortise bathroom lock	PVD/ COP	50016915
<b>AR3313-50/96-PVD-SBR</b>	Magnetic mortise bathroom lock	PVD/ SBR	50016921
<b>AR3313-50/96-MNP</b>	Magnetic mortise bathroom lock	TTM	50016933





Application: with the door in the closed position the lock bolt is drawn into the strike plate removing the need for a primary latch bolt

# Explanation of Attributes and Symbols

## Explanation of Attributes

Denomination	Description	Attribute
<b>Brand attributes</b>	<ul style="list-style-type: none"> <li>distinguish all HOPPE products</li> <li>convey the brand promise</li> </ul>	 10-year guarantee on the mechanical operation
		 Made in Europe
		 DIN EN ISO 14001 Environmentally-considerate manufacturing
<b>Special attributes</b>	<ul style="list-style-type: none"> <li>underline a unique selling proposition or an essential additional benefit of the HOPPE brand product</li> </ul>	 10-year surface guarantee
		 quick interlocking assembly of door handles
<b>Product attributes</b>	<ul style="list-style-type: none"> <li>present important information on a product or a benefit of the product</li> <li>are identified with the pictograms designed by HOPPE</li> </ul>	 Stainless steel
		 Solid brass

## Explanation of Symbols

	Door thickness (in mm)
	Spindle size (in mm)
<b>duraplus</b>	HOPPE divides its product range into three lines based on the customers' different requirements in price and perception of value – duravert, duraplus and duranorm. duraplus is the medium range.

## HOPPE Finish Chart

### Aluminium



**F9016M**  
traffic white matt



**F9714M**  
black matt

### Stainless steel



**F69**  
satin



**F78-1-R**  
light satin brass effect –  
**Resista**



**F84-1-R**  
copper-coloured  
satin – **Resista**

### Brass



**F41-R**  
brushed chrome – **Resista**



**F42-R**  
satin nickel – **Resista**



**F49-R**  
polished chrome –  
**Resista**



**F78-1-R**  
natural-brass-coloured  
satin – **Resista**



**F84-1-R**  
copper-coloured  
satin – **Resista**



**F96-1-R**  
satin black – **Resista**



**F97-1-R**  
satin anthracite –  
**Resista**



**F9714M**  
black matt

## ARRONE Finish Chart



**MNP**  
Matt nickel  
plated



**WHT**  
White



**BLK**  
Black



**PVD/COP**  
Copper



**PVD/SBR**  
PVD-Satine  
brass



**TTM**  
Titanium

For technical reasons, the colour representation in product images may differ from the actual product. We do not guarantee or warrant colour accuracy of the products shown.

HOPPE Nordic Countries Oy  
Hyrylänkatu 8  
FI-04300 Tuusula

Tel. +358 9 25 84 34 24  
info.nordic@hoppe.com  
www.hoppe.com

---

## Trading partners in the Nordic Countries

Trading partner in Sweden:

BESLAGSKONSULT AB  
Neogatan 11  
SE-431 53 Mölndal

Tel. +46 31 91 40 30  
info@beslagskonsult.se  
www.beslagskonsult.se

Trading partner in Finland:

Scancerco Oy  
Mestarintie 13  
FI-01730 Vantaa

Tel. +358 40 16 25 227  
myynti@scancerco.fi  
www.scancerco.fi

Trading partner in Denmark:

KH TRADE AS  
Theilgaard's Allé 3A, "Den Hvide By"  
DK-4600 Køge

Tel. +45 70 23 40 30  
info@kh-trade.dk  
www.kh-trade.dk

Trading partner in Norway:

BOYESEN & MUNTHE A/S  
Tvetenveien 152  
NO-0671 Oslo

Tel. +47 23 34 70 00  
post@boyesen-munthe.no  
www.boyesen-munthe.no